



BELMED INC.

**Nitrous Oxide/Oxygen
GAS SUPPLY
SYSTEMS**

Mailing Address:

P.O. Box 247 • Red Lion, PA 17356-0247

Shipping Address:

887 Delta Rd. • Red Lion PA 17356

717-246-5500 • Fax: 717-246-7586

www.belmedinc.com

TOLL FREE: 888-723-5893

Confidential PRICE LIST

EFFECTIVE 11-30-05

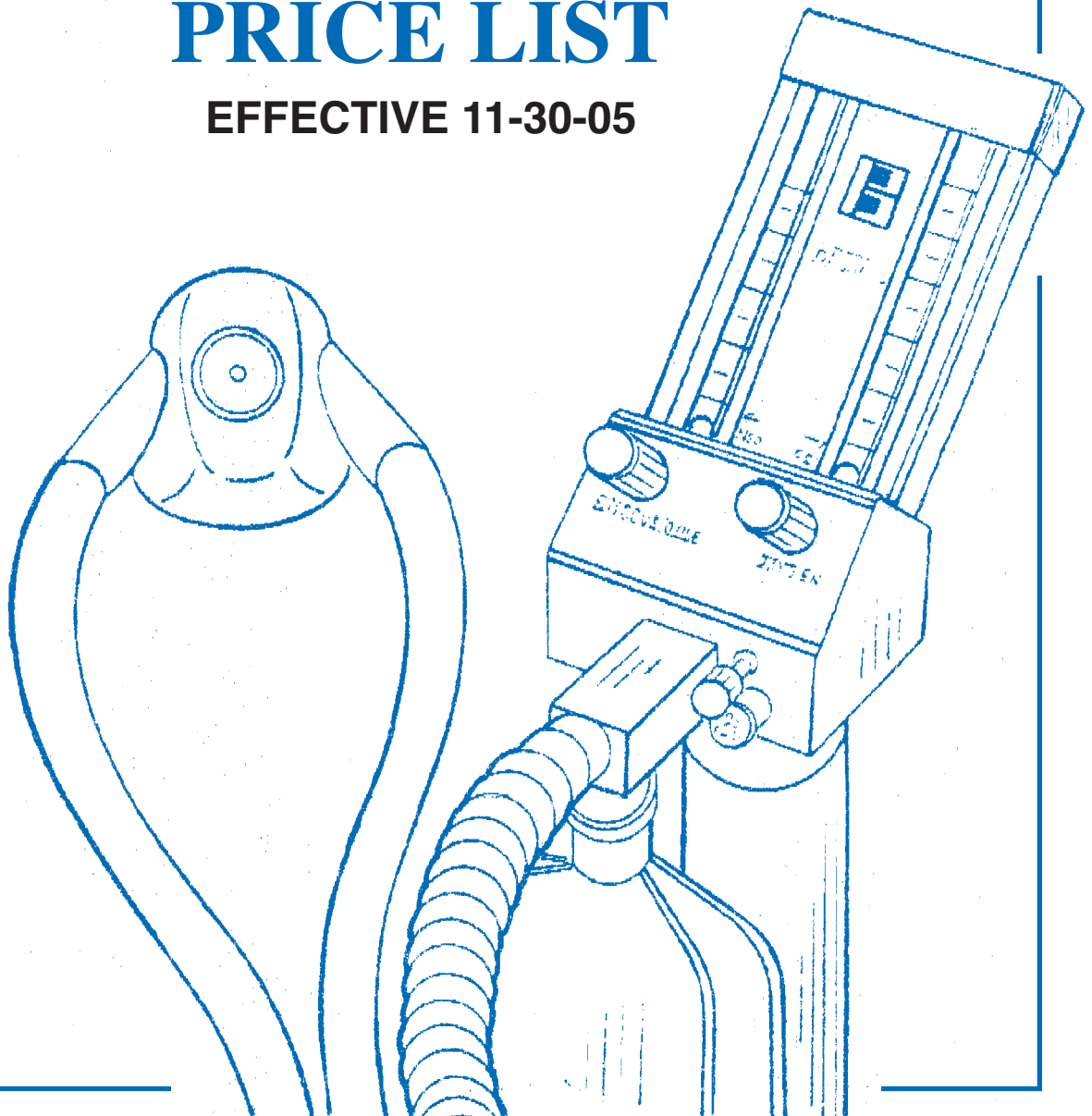



BELMED INC.

BELMED PRICE LIST - EFFECTIVE 11-30-05
This Price List Supersedes all Previous Price Lists

At Belmed, Inc. we pride ourselves on producing a quality product at a reasonable price. When you call Belmed you get to talk to real people -- no voice mail and quick resolutions to your customer service and technical questions. We value your business and will do our best to keep you as a satisfied customer.

Belmed also has the expertise and capability of manufacturing special parts for your needs.

Check our Web Site at www.belmedinc.com for monthly sales specials.

Minimum Order \$25.00

INDEX

ACCESSORIES, RECOVERY ROOM (ORAL SURGERY)	27-28
CONNECTORS, QUICK CONNECT, MALE 02/N20/VAC	18
CONNECTORS, NITROGEN, HALL/STRYKER	28
COUPLERS, QUICK CONNECT, FEMALE 02/N20/VAC	14
FITTINGS, CHROME PLATED, DISS & PIPE	29
FLOWMETER SYSTEMS - 02/N20	5-6
FLOWMETER - 02 THERAPY	28
FLOWMETER ACCESSORIES, ORAL SURGERY	27
FLOWMETER - STANDS, MOUNTS, BRACKETS, ADAPTERS	7,8,9
HOSE ASSEMBLIES, MALE Q.C., FEMALE Q.C., (COUPLERS) DISS, BULK HOSE	13-14-15
MANIFOLD SYSTEMS - 02/N20-02 ONLY	19-20-21
MANIFOLD SYSTEMS - NITROGEN	28
MANIFOLD SYSTEMS - REPLACEMENT PARTS	22
OUTLET STATIONS, QUICK CONNECT, 02/N20/VAC	23-24
OUTLET STATIONS, REPLACEMENT PARTS	25
OUTLET STATIONS, NITROGEN DISS (ORAL SURGERY)	28
OUTLET STATIONS, SEE SHUT OFF VALVES	16-17
POLICIES	31
RATIO FLOW CONTROL	3
REGULATORS - 02/N20/N2	26
RESUSCITATION EQUIPMENT	12
RUBBER GOODS - INHALERS, BAGS, TUBES	10-11
SHUT-OFF VALVES, 1/4 TURN AND KITS - 02/N20/VAC	16-17
VACUUM COLLECTION SYSTEMS	27
YOKE BLOCKS 02/N20 FOR SMALL CYLINDER	7
YOKE BLOCKS, REPLACEMENT PARTS	25
ZONE VALVE, MANIFOLD SYSTEM SHUT-OFF 02/N20	20

MINIMUM ORDER \$25.00

New - From Belmed Inc.:

Ratio Flow Control

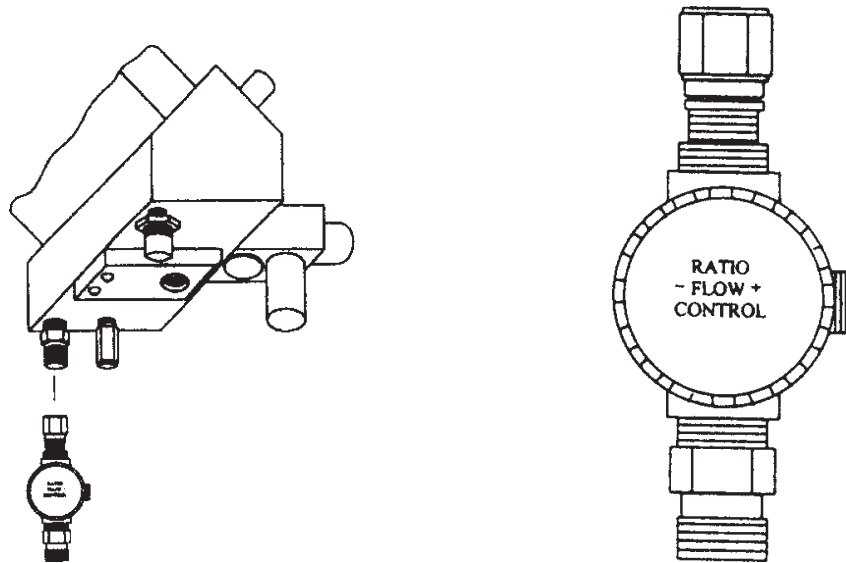

Adds new versatility to current minimum 3 Liter Oxygen type Flowmeters.

O₂ flow rate can be reduced to as low as 1 liter per minute to match patient breathing volumes while still maintaining minimum 30% oxygen and 70% maximum nitrous oxide.

Total flow may be increased or decreased while still maintaining pre-selected percentages.

Ideal for pedodontics or anywhere the flexibility to match patient volumes is desired.

Equilibrium of flow rates between flowmeter and scavenging systems more easily maintained.

Device is inexpensive and compact (Aprox 1 1/2"W x 3 1/2"L). Installation is quick and simple. Unit interconnects between flowmeter and oxygen supply hose. No special tools required.

5000-93	Ratio Flow Control		130.00
----------------	---------------------------	--	---------------

BELMED PC-7 FLOWMETER

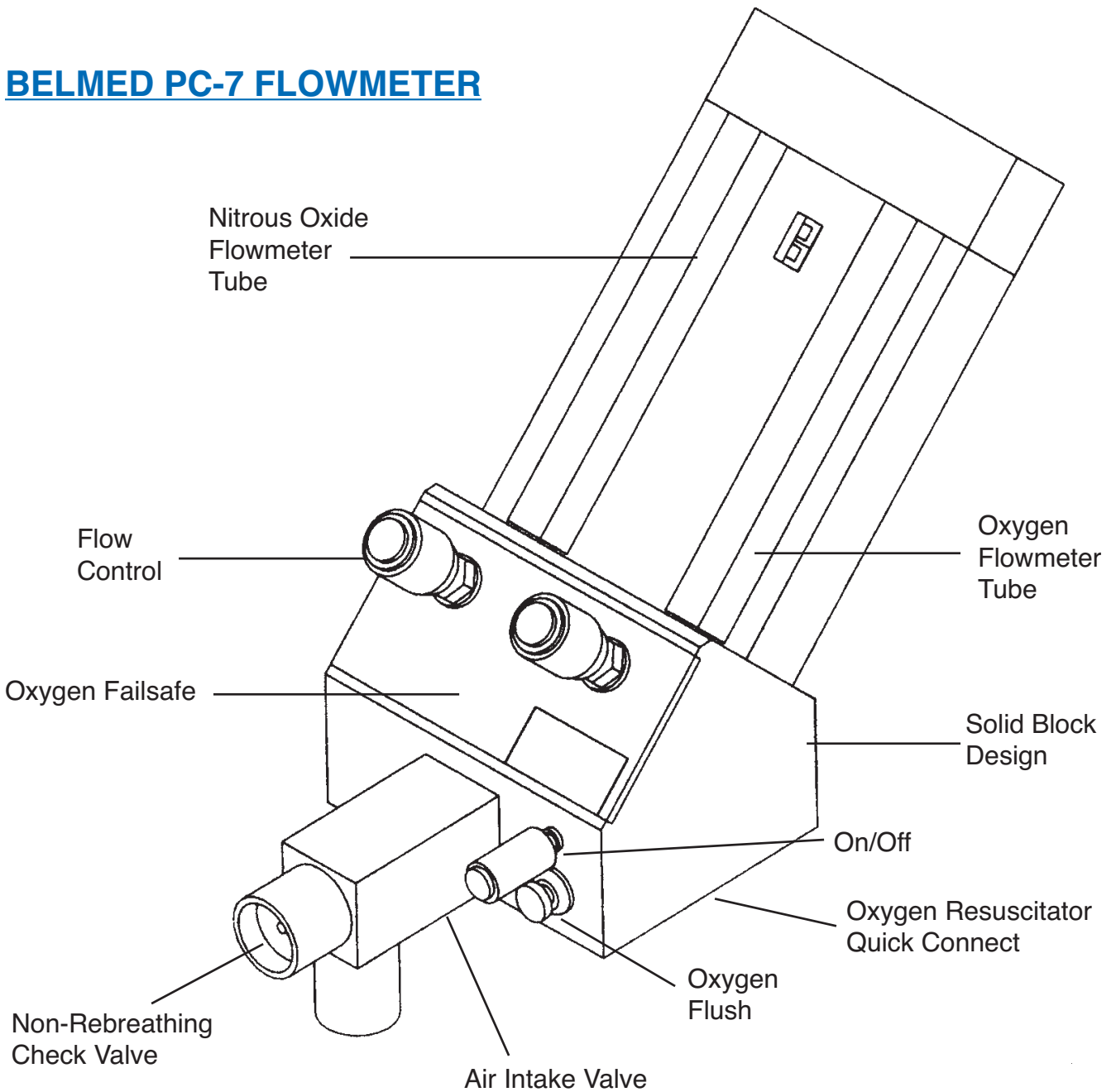









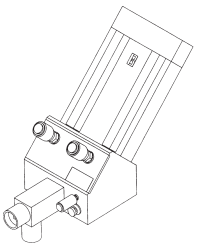
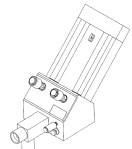

BELMED PC7 - Specifications

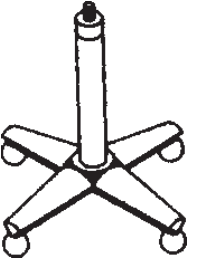
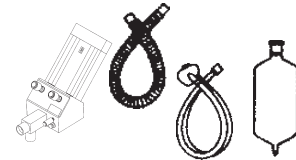
Flowmeter Head Dimensions	8 3/4"H x 3 3/4"W x 10 1/4"D
Weight of Flowmeter Head	5 LBS.
Bag and Outlet Diameter	22mm (Approx. 7/8")
Oxygen Flow Range	3-10 LPM
Nitrous Oxide Flow Range	0-7 LPM
Failsafe Type	Proportional

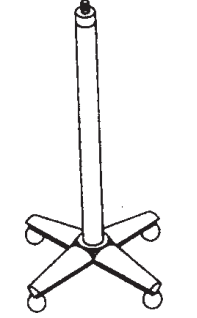
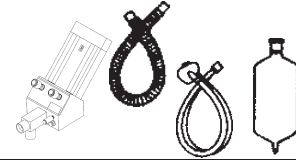
FLOWMETER SYSTEMS

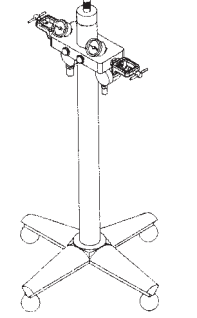
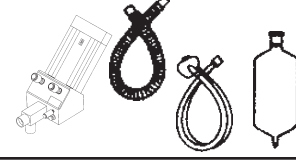
STOCK NUMBER & DESCRIPTION

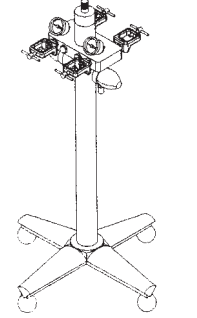
LIST







		5000 Flowmeter Head Only Note: Specify Mounting adapter MS- Mobile Stand or WC- Wall or Cabinet	1480.00
		5001 Head w/Standard Rubber Goods Includes: Inhaler, Tube & Bag Specify Mounting Adapter (See Above)	1740.00
		5001S Head w/Scavenger Rubber Goods Includes: Scavenger Inhaler, tube & Bag Specify Mounting Adapter (See Above)	1990.00
		5002-SH Flowmeter System - Short Mobile Stand Includes: Head, Mobile Stand, (Hght. 30"-40") Standard Rubber Goods Includes: Inhaler, Tube & Bag	2010.00
		5002-SH-S Same as above with Scavenger Rubber Goods	2260.00
		5002 Flowmeter System - Mobile Stand Includes: Head, Tall Mobile Stand, (Hght. 42"-52") Standard Rubber Goods Includes: Inhaler, Tube & Bag	2010.00
		5002S Same as above with Scavenger Rubber Goods	2260.00
		5132 Flowmeter w/ 2 cyl. Yoke Block Includes: Head, Tall Mobile Stand w/ Standard Rubber Goods, #5013 2 cyl. Yoke Block w/DISS Hoses - 3 Ft.	3140.00
		5132-S Same as above with Scavenger Rubber Goods	3340.00
		5142 Flowmeter w/ 4 cyl. Yoke Block Includes: Head, Tall Mobile Stand w/ Standard Rubber Goods, #5014 4 cyl. Yoke Block w/DISS Hoses - 3 Ft.	3540.00
		5142-S Same as above with Scavenger Rubber Goods	3740.00

NOTE: ORDER SUPPLY HOSES SEPARATELY - PG. 13

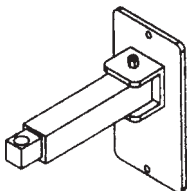
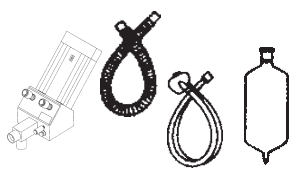
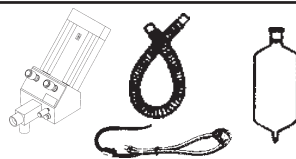
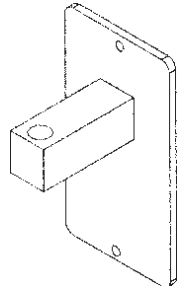
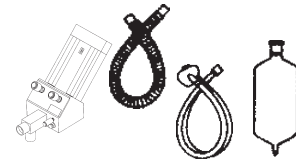
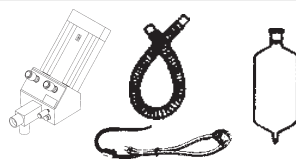
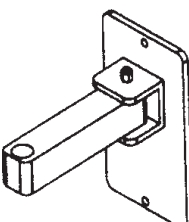
FLOWMETER SYSTEMS

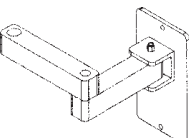
STOCK NUMBER & DESCRIPTION

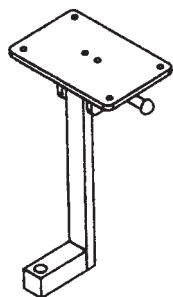
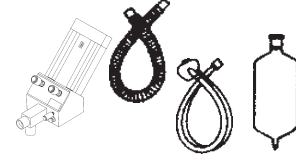
LIST

		5003-T Flowmeter System -Telescoping Arm Includes: Head & Arm w/ Standard Rubber Goods Wall arm extends controls approx 24" from wall		2010.00
		5003-T-S Same as above with Scavenger Rubber Goods		2260.00
		5003-STA Flowmeter System - Stationary Arm Includes: Head & Arm w/ Standard Rubber Goods		2010.00
		5003-S-STA Same as above with Scavenger Rubber Goods		2260.00
		5003-SW Flowmeter System - 8" Swivel Arm Includes: Head & Arm w/ Standard Rubber Goods		2010.00
		5003-S-SW Same as above with Scavenger Rubber Goods		2260.00
		5003DSW Flowmeter System - 8" Double Swivel Arm Includes: Head & Arm w/ Standard Rubber Goods		2010.00
		5003S-DSW Same as above with Scavenger Rubber Goods		2260.00
		5004 Flowmeter System - Cabinet Mount Includes: Head & Cabinet Mount w/ Standard Rubber Goods		2010.00
		5004-S Same as above with Scavenger Rubber Goods		2260.00

MOBILE STANDS, STANDS w/ YOKE BLOCKS, YOKE BLOCKS ONLY - All Manufacturers

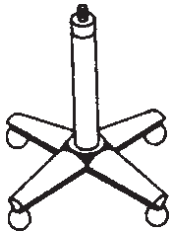
SHORT STAND, 19" HIGH w/ 10" HGT. ADJ.				LIST
	5010-SH-BD	BELMED, ACCUTRON PC		280.00
	5010-SH-FS	FRASER/MATRX		320.00
	5010-SH-PR	PORTER COASTAL		320.00
	5010-SH-MK	McKESSON-MDT ANALOR II, III, IV		320.00

TALL STAND, 32" HIGH w/ 10" HGT. ADJ.

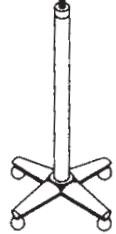
	5010-TS-BD	BELMED, ACCUTRON PC		280.00
	5010-TS-FS	FRASER/MATRX		320.00
	5010-TS-PR	PORTER COASTAL		320.00
	5010-TS-MK	McKESSON-MDT ANALOR II, III, IV		320.00

TALL STAND WITH 2 CYL. YOKE BLOCK

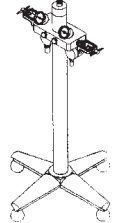
	5210-BD	BELMED, ACCUTRON PC		1440.00
	5210-FS	FRASER/MATRX		1510.00
	5210-PR	PORTER COASTAL		1510.00
	5210-MK	McKESSON-MDT ANALOR II, III, IV		1510.00

TALL STAND WITH 4 CYL. YOKE BLOCK

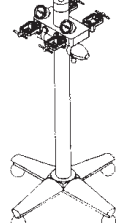
	5410-BD	BELMED, ACCUTRON PC		1870.00
	5410-FS	FRASER/MATRX		1910.00
	5410-PR	PORTER COASTAL		1910.00
	5410-MK	McKESSON-MDT ANALOR II, III, IV		1910.00

5013 2 CYL. YOKE BLOCK ONLY

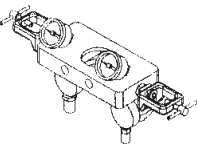
	One 02 Yoke, One N20 Yoke, Block, Gauges, Regulators, 36" Diss Hoses, Cyl. Wrench - Fits Belmed, Porter, Accutron PC and Fraser Tall Mobile Stands		1200.00
---	--	--	---------

5014 4 CYL. YOKE BLOCK ONLY

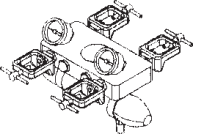
	Two 02 Yokes, Two N20 Yokes, Block, Gauges, Regulators, 36" Diss Hoses, Check Valves, Cyl. Wrench, 2 Yoke Plugs Fits Belmed, Porter, Accutron PC and Fraser Tall Mobile Stands		1600.00
---	--	--	---------

MOUNTING BRACKETS, WALL/CABINET - All Manufacturers

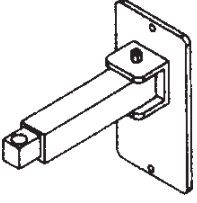
TELESCOPING WALL ARM				LIST
	5011-TL-BD	BELMED		280.00
	5011-TL-FS	FRASER/MATRX		280.00
	5011-TL-PR	PORTER, ACCUTRON PC COASTAL		320.00
	5011-TL-MK	McKESSON-MDT ANALOR II, III, IV		320.00

DOUBLE SWIVEL WALL ARM (Will Fit 10" Wide Cabinet)

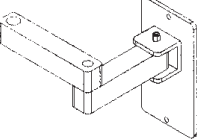
	5011-DS-BD	BELMED		280.00
	5011-DS-FS	FRASER/MATRX		280.00
	5011-DS-PR	PORTER, ACCUTRON PC COASTAL		320.00
	5011-DS-MK	McKESSON-MDT ANALOR II, III, IV		320.00

8" SWIVEL ARM

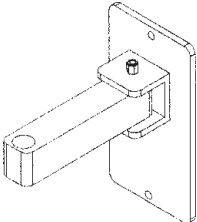
	5011-SW-BD	BELMED		280.00
	5011-SW-FS	FRASER/MATRX		280.00
	5011-SW-PR	PORTER, ACCUTRON PC COASTAL		320.00
	5011-SW-MK	McKESSON-MDT ANALOR II, III, IV		320.00

STATIONARY ARM

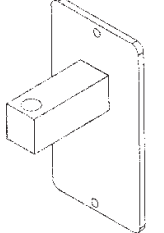
	5011-ST-BD	BELMED		280.00
	5011-ST-FS	FRASER/MATRX		280.00
	5011-ST-PR	PORTER, ACCUTRON PC COASTAL		320.00
	5011-ST-MK	McKESSON-MDT ANALOR II, III, IV		320.00

CABINET - FLIPOUT BRACKET

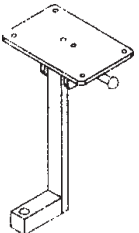
	5012-BD	BELMED		280.00
	5012-FS	FRASER/MATRX - Top Mount Only (See Pg. 9)		320.00
	5012-PR	ACCUTRON PC PORTER / COASTAL		320.00

CONTACT FACTORY FOR CONFIGURATIONS NOT LISTED

MOUNTING ADAPTERS - All Manufacturers

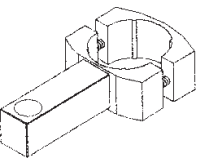
2" POST MOUNT			LIST
	5005-PM-BD	BELMED HEAD	280.00
	5005-PM-FS	FRASER/MATRX (MDM and RA Top Mount Only (See Below))	280.00
	5005-PM-PR	PORTER, COASTAL, ACCUTRON PC FLOWMETER HEAD	320.00

ARM ADAPTER

	5100-WC-BD	BELMED HEAD TO BELMED WALL ARM OR CABINET BKT.	44.00
	5100-WC-PR	BELMED HEAD TO PORTER, ACCUTRON PC WALL ARM	44.00
	5100-WC-FS	BELMED HEAD TO FRASER/MATRX WALL ARM	44.00

MOBILE STAND ADAPTER

	5100-MS-BD	BELMED HEAD TO BELMED MOBILE STAND AND ACCUTRON PC	48.00
	5100-MS-PR	BELMED HEAD TO PORTER, COASTAL, MOBILE STAND	48.00
	5100-MS-FS	BELMED HEAD TO FRASER/MATRX MOBILE STAND	48.00

BI-MOUNT ADAPTER

	5100-BI-BD	UNIVERSAL MOUNTING ADPTR. ADAPTS BELMED HEAD TO BELMED WALL ARM, CABINET BRACKET, MOBILE STAND	60.00
---	------------	--	-------

TOP MOUNT ADAPTER, FRASER/MATRX

	5100-TM-FS	TOP MOUNT BLOCK AND STUD FOR FRASER/MATRX MDM or RA FLOWMETER	100.00
---	------------	---	--------

STUD

	5100-ST-FS	MOUNTING STUD 5/8" DIA. x 3" LG. FRASER/MATRX RA or MDM	48.00
---	------------	---	-------

MS ADAPTER

	5100-AD-FS	MOBILE STAND ADAPTER FRASER/MATRX RA or MDM TO BELMED MOBILE STAND	48.00
---	------------	--	-------

CONTACT FACTORY FOR SPECIAL ADAPTERS







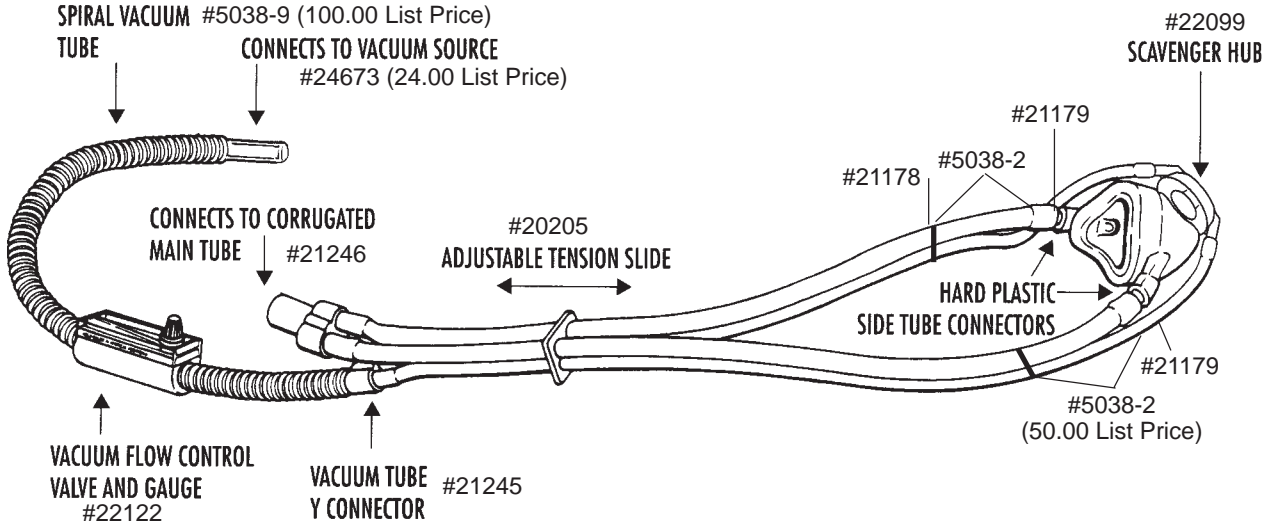

SCAVENGING RUBBER GOODS

SCAVENGER INHALER ONLY			LIST
	5038-S	See description below Different size hoods may be ordered separately (see below) S=Small (Pedo) Hood M = Adult Hood L= Large Hood Autoclavable	472.00
	5038-M		
	5038-L		

SCAVENGER PACKAGE

	5039-S	Includes Scavenger Inhaler (Specify Size) 3 Ltr. Breathing Bag and 7/8" x 32" Breating Tube	536.00
	5039-M		
	5039-L		



SCAVENGER REPLACEMENT PARTS / DESCRIPTION

			
	20205	SLIDE TUBE, DOUBLE	24.00
	21178	DOUBLE CONNECTOR (2/Pkg.)	24.00
	21179	SGL. CONN. NASAL HOOD (2/Pkg.)	24.00
	21246	LARGE "Y" CONNECTOR	24.00
	21245	SMALL "Y" CONNECTOR	24.00
	22099	SCAVENGING HUB (Clear Disc)	72.00
	22122	VACUUM GAUGE	120.00
	5031-S	HOOD, MULTI-USE-SMALL (PEDO)	72.00
	5031-M	HOOD, MULTI-USE-MED (Adult)	72.00
	5031-L	HOOD, MULTI-USE-LARGE	72.00

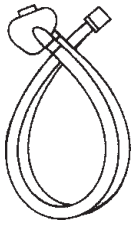

STANDARD INHALER (Non-Scavenging) RUBBER GOODS

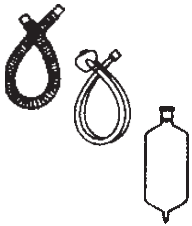
STANDARD INHALER ONLY			LIST
	5020-S	AUTOCLAVABLE HOOD Specify Size: S = Small (PEDO) M = Medium (ADULT) L = Large	200.00
	5020-M		
	5020-L		

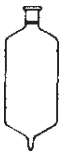
RUBBER GOODS PACKAGE

	5030-S	INCLUDES: STANDARD INHALER 3 LTR. BAG (Latex) BREATHING TUBE Specify Size: S-M-L	264.00
	5030-M		
	5030-L		
	5025	BREATHING TUBE 22mm I.D. X 32" Lg. Corrugated, Black	32.00
	5027	BREATHING TUBE, Plastic - 5 Ft. Lg.	32.00
	5026-N	BREATHING BAG 3 LTR. NEOPRENE-Black	38.00



INHALER REPLACEMENT PARTS

	5031-S	HOOD ONLY Fits Standard and Scavenger Inhaler Autoclavable Specify Size: S-M-L Includes Valve	84.00
	5031-M		
	5031-L		
5033	SIDE TUBING, Grey Specify Length	8.00/Ft.	
	5034	CONNECTOR SIDE TUBE to HOOD Pkg./2	30.00
	5035	"Y" CONNECTOR SIDE BREATHING TUBES TO BREATHING TUBE	40.00
5032	SLIDE / CINCH For DBL. SIDE TUBING	20.00	

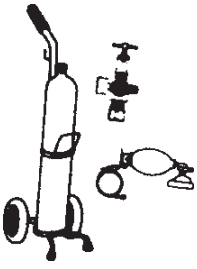
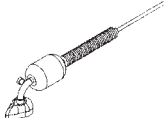

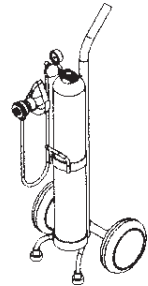

EMERGENCY OXYGEN EQUIPMENT

MANUAL RESUSCITATOR			LIST
	5048	PORTABLE SYSTEM Includes - "E" Cyl. Cart 0-15 LPM REGULATOR Manual Resuscitator Child and Adult Face Masks Cyl. Wrench (Cylinder not included)	740.00
	5043	MANUAL RESUSCITATOR ONLY Includes - Resuscitator w/Child and Adult Face Masks	188.00

DEMAND / RESUSCITATOR VALVE

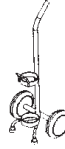
	5041	PORTABLE SYSTEM Includes - Resuscitator Valve w/8" Hose, Hand Tite Diss. Ftg., "E" Cyl. Cart 50 PSI Preset Regulator Child and Adult Face Masks Cyl. Wrench (Cylinder not included)	1125.00
	5040	DEMAND VALVE 2w/Imperial Type Quick Connect for Belmed, Porter, Accutron PC, Flowmeters (will also conn. to Porter style outlet stations)	600.00
	5040-2C	DEMAND VALVE For Quick Connect Outlet Stations Specify Type Outlet Station OH=OHIO, PN=PURITAN, CN=Chemetron	640.00
	5040-D	DEMAND VALVE with 02 DISS. Connection - Has Hand-Tite 02 DISS Nut. w/8' Hose	600.00

REPLACEMENT PARTS

	5041-10A	E CYLINDER CART	112.00
	9033 (C)	FACE MASK (<i>Specify Child or Adult</i>)	68.00
	9033 (A)	Clear with Chin Support	
	6006	REGULATOR - PRESET 50 PSI - E Cyl. Yoke for Demand Resuscitator Valve	296.00
	6007	REGULATOR - 0 - 15 LPM For Manual Resuscitator	296.00
		CYLINDER WRENCH	28.00

HOSE ASSEMBLIES

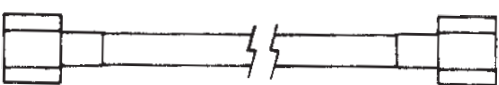
DISS STYLE - DISSNUT x DISSNUT			LIST
8005	OXYGEN (O2)		80.00 1-5 Ft.
8006	NITROUS OXIDE (N2O)		
8007	VACUUM (VAC)		
8008	NITROGEN (N2)		

QUICK CONNECT STYLE - MALE Q.C. x DISSNUT (Scavenger Assy's. Male Q.C. x Scav. Adapter Kit (All Mfgs) SPECIFY LENGTH

PURITAN			
8000-PN	OXYGEN (O2)		96.00 1-5 Ft.
8001-PN	NITROUS OXIDE (N2O)		
8010-PN	SCAVENGING (VAC)		

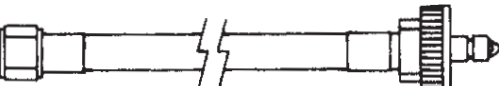
OHIO (MATRX)			
8000-OH	OXYGEN (O2)		96.00 1-5 Ft.
8001-OH	NITROUS OXIDE (N2O)		
8010-OH	SCAVENGING (VAC)		

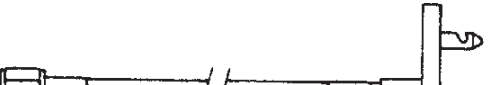
CHEMETRON (NCG)			
8000-CN	OXYGEN (O2)		96.00 1-5 Ft.
8001-CN	NITROUS OXIDE (N2O)		
8010-CN	SCAVENGING (VAC)		

OXEQUIP			
8000-OP	OXYGEN (O2)		96.00 1-5 Ft.
8001-OP	NITROUS OXIDE (N2O)		
8010-OP	SCAVENGING (VAC)		

PORTER / ACCUTRON			
8060	O2/N2O DUPLEX		1-5 Ft. 184.00
8010-PR	SCAVENGING (VAC)		96.00 1-5 Ft.

HOSE ASSEMBLY - FEMALE QUICK COUPLER x DISS NUT

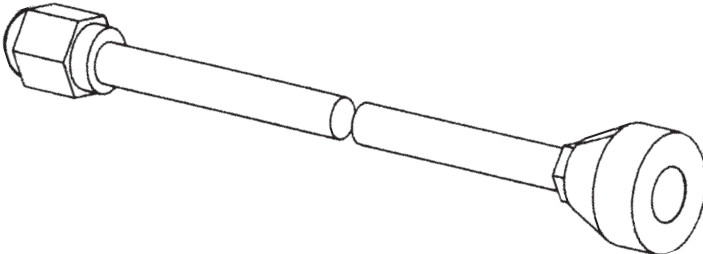
FEMALE QUICK COUPLERS X DISSNUT - SPECIFY LENGTH			LIST
			

PURITAN

8000-PNF	OXYGEN (O2)		192.00 1-5 Ft.
8001-PNF	NITROUS OXIDE (N2O)		
8002-PNF	VACUUM (VAC)		

OHIO

8000-OHF	OXYGEN (O2)		192.00 1-5 Ft.
8001-OHF	NITROUS OXIDE (N2O)		
8002-OHF	VACUUM (VAC)		

CHEMETRON

8000-CNF	OXYGEN (O2)		192.00 1-5 Ft.
8001-CNF	NITROUS OXIDE (N2O)		
8002-CNF	VACUUM (VAC)		

OXEQUIP

8000-OPF	OXYGEN (O2)		192.00 1-5 Ft.
8001-OPF	NITROUS OXIDE (N2O)		
8002-OPF	VACUUM (VAC)		

PORTER / ACCUTRON

8060-PRF	OXYGEN/NITROUS OXIDE DUPLEX		400.00
8002-PRF	VACUUM		196.00 1-5 Ft.

COUPLERS ONLY X MALE DISS FOR DISS HOSE CONNECTION

8011*	OXYGEN (O2)		156.00
8012*	NITROUS OXIDE (N2O)		
8013*	VACUUM (VAC)		
<p>*ORDERING INFORMATION: Add appropriate 2 letter suffix to coupler part number for desired brand type connector</p>		<p>PN = PURITAN OH = OHIO CN = CHEMETRON</p>	

HOSE ASSEMBLIES, MALE x FEMALE QUICK CONNECT

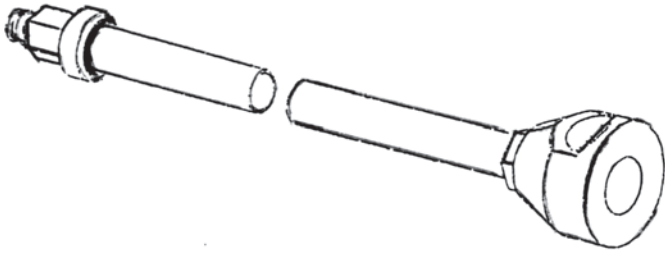
SPECIFY LENGTH	LIST
	

PURITAN

8000 PNF/M	OXYGEN (O2)		330.00
8001 PNF/M	NITROUS OXIDE (N2O)		1-5 FT.
8002 PNF/M	VACUUM (VAC)		

OHIO

8000 OHF/M	OXYGEN (O2)		330.00
8001 OHF/M	NITROUS OXIDE (N2O)		1-5 FT.
8002 OHF/M	VACUUM (VAC)		

CHEMTRON

8000 CNF/M	OXYGEN (O2)		330.00
8001 CNF/M	NITROUS OXIDE (N2O)		1-5 FT.
8002 CNF/M	VACUUM (VAC)		

OXEQUIP

8000 OPF/M	OXYGEN (O2)		330.00
8001 OPF/M	NITROUS OXIDE (N2O)		1-5 FT.
8002 OPF/M	VACUUM (VAC)		

PORTER/ACCUTRON

8060-PRF/M	OXYGEN/NITROUS OXIDE DUPLEX		550.00
8002 PRF/M	VACUUM		296.00
			1-5 FT.

1/4 TURN SHUT OFF VALVE w/DISS CHECK VALVE, SOLDER TYPE

Ideal for cabinetry etc. instead of outlet stations. Additional DISS check valve remains closed until hose is connected to prevent inadvertent opening of valve. Available in kits with DISS/DISS hoses and DISS hose by female quick connect couplers. DISS caps also available for a gas-tight seal when valves are not intended to be used on a long term basis. (See Pg. 17 for solderless style)

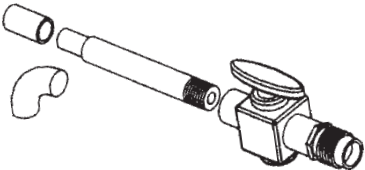
SHUT-OFF VALVE ONLY		LIST
		
7302	N20 SHUT OFF VALVE ASSY.	120.00
7304	O2 SHUT OFF VALVE ASSY.	120.00

SHUT-OFF w/4 FT. DISS X DISS HOSES, O2/N20 - 1-5 Ft.Specify

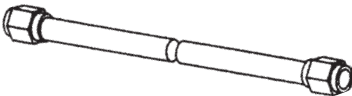
		
7303	SET O2/N20 VALVES AND DISS x DISS HOSES	330.00

SHUT-OFF KIT w/ DISS x Q.C. COUPLER HOSES x 1-5 Ft.Specify

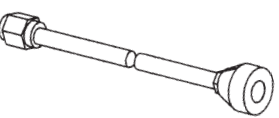
		
7305-PN	SET O2/N20 VALVES w/DISS x PURITAN Q.C. COUPLERS	600.00
7305-OH	SET O2/N20 VALVES w/DISS x OHIO Q.C. COUPLERS	600.00
7305-CN	SET O2/N20 VALVES w/DISS x CHEMETRON Q.C. COUPLERS	600.00
7305-PR	SET O2/N20 VALVES w/DISS x PORTER Q.C. COUPLERS	600.00

VACUUM SHUT-OFF VALVES AND ASSEMBLIES

7306	SHUT OFF VALVE ONLY	120.00
7306-PNF	SHUT OFF w/DISS x PURITAN FEM. CPLR. - 1-5 Ft. HOSE	300.00
7306-OHF	SHUT OFF w/DISS x OHIO FEM. CPLR. - 1-5 Ft. HOSE	300.00
7306-CNF	SHUT OFF w/DISS x CHEMETRON FEM. CPLR. - 1-5 Ft. HOSE	300.00
7306-PRF	SHUT OFF w/DISS x PORTER FEM. CPLR. - 1-5 Ft. HOSE	300.00
NOTE: HOSE ASSYS. SOLD 1-5 FT. LENGTHS - Specify Length		

	1242-2	O2 DISS GAS TIGHT CAP w/CHAIN	40.00
	1000CP	N20 OR VAC DISS GAS TIGHT CAP w/CHAIN	40.00
INDIVIDUAL COUPLERS AND DISS X CPLR. HOSE ASSYS. - PG. 14			
NOTE: SPECIAL CONNECTOR STYLES AVAILABLE - CONTACT FACTORY			

1/4 TURN SHUT-OFFS - Solderless Style - 45° Flare

In addition to our silver-solder type shut-offs, we offer solderless - 45° Flare style connections. Includes 45° male nipple and nut for pipeline connection in applications where silver brazing is not desired or suitable. Valve incorporates S.S. Ball Valve and D.I.S.S. Check Valve.

NOTE: Valves with hose assy's available 1 to 5 Ft. lengths - Specify length desired.

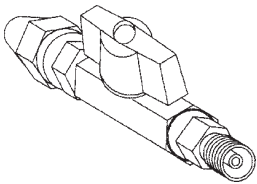
SHUT-OFF VALVE ONLY, 45° Flare Connection		LIST
		
7312	N20 SHUT OFF VALVE FOR 3/8" OD PIPELINE	110.00
7314	02 SHUT OFF VALVE FOR 1/2" OD PIPELINE	110.00

SHUT-OFF SET - 02/N20 WITH DISS to DISS HOSES, 1-5 Ft. Specify

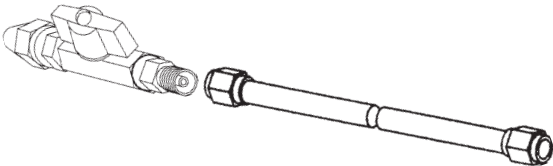
		
7313	SET 02/N20 - 45° FLARE - DISS to DISS HOSES x 1-5 FT. Specify	332.00

SHUT-OFF SET - 02/N20 WITH DISS to FEMALE COUPLER, 1-5 Ft. Specify

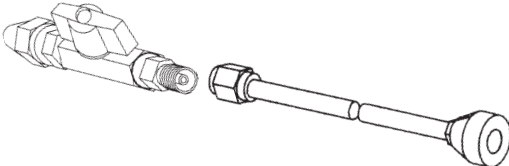
		
7315-PN	SET O2/N20 VALVES w/DISS x PURITAN Q.C. COUPLERS	600.00
7315-OH	SET O2/N20 VALVES w/DISS x OHIO Q.C. COUPLERS	600.00
7315-CN	SET O2/N20 VALVES w/DISS x CHEMETRON Q.C. COUPLERS	600.00
7315-PR	SET O2/N20 VALVES w/DISS x PORTER Q.C. COUPLERS	600.00

VACUUM SHUT-OFF VALVES AND ASSEMBLIES

7316	SHUT OFF VALVE ONLY	110.00
7316-PNF	SHUT OFF w/DISS x PURITAN FEM. CPLR. - 1-5 Ft. HOSE	296.00
7316-OHF	SHUT OFF w/DISS x OHIO FEM. CPLR. - 1-5 Ft. HOSE	296.00
7316-CNF	SHUT OFF w/DISS x CHEMETRON FEM. CPLR. - 1-5 Ft. HOSE	296.00
7316-PRF	SHUT OFF w/DISS x PORTER FEM. CPLR. - 1-5 Ft. HOSE	296.00
NOTE: HOSE ASSYS. SOLD 1-5 FT. LENGTHS - Specify Length		

BELMED INC., Mailing Address: P.O. BOX 247, RED LION, PA 17356-0247

Shipping Address: 887 DELTA ROAD, RED LION, PA 17356

717-246-5500 FAX: 717-246-7586

www.BELMEDINC.COM

QUICK CONNECTS

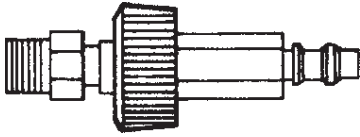
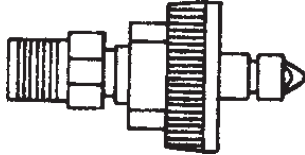
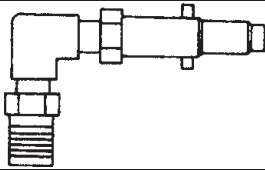
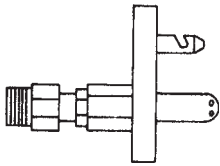
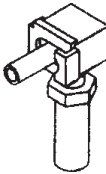
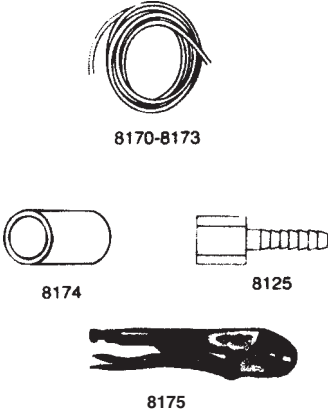
MALE QUICK CONNECTS X MALE DISS (For Attachment to DISS X DISS HOSES) Scavenger (Vac) CONNECTORS ARE MALE Q.C. x 1/4 HOSE BARB				
PURITAN				LIST
	8151-PN	OXYGEN (O2)		72.00
	8152-PN	NITROUS OXIDE (N2O)		
	8153-PN	SCAVENGING (VAC)		
OHIO				
	8151-OH	OXYGEN (O2)		72.00
	8152-OH	NITROUS OXIDE (N2O)		
	8153-OH	SCAVENGING (VAC)		
OXEQIP				
	8151-OP	OXYGEN (O2)		72.00
	8152-OP	NITROUS OXIDE (N2O)		
	8153-OP	SCAVENGING (VAC)		
CHEMETRON (NCG)				
	8151-CN	OXYGEN (O2)		72.00
	8152-CN	NITROUS OXIDE (N2O)		
	8153-CN	SCAVENGING (VAC)		
PORTER / ACCUTRON				
	8153-PR	SCAVENGING (VAC)		96.00
	Note: 02/N20 DUPLEX SOLD AS HOSE ASSY. ONLY (Page 13)			
BULK HOSE, FERRULES, CRIMPERS				
 <p style="font-size: small; margin: 5px 0;">8170-8173</p> <p style="font-size: small; margin: 5px 0;">8174 8125</p> <p style="font-size: small; margin: 5px 0;">8175</p>	8170	OXYGEN (O2) HOSE		HOSE 4.00/Ft.
	8171	NITROUS OXIDE (N2O) HOSE		
	8172	SCAVENGING (VAC) HOSE		
	8173	NITROGEN (N2) HOSE		1.00
	8174	FERRULES, for above HOSE		
	8175	CRIMPING TOOL		
See Page 29 For Hose Fittings			120.00	

MANIFOLD SYSTEMS

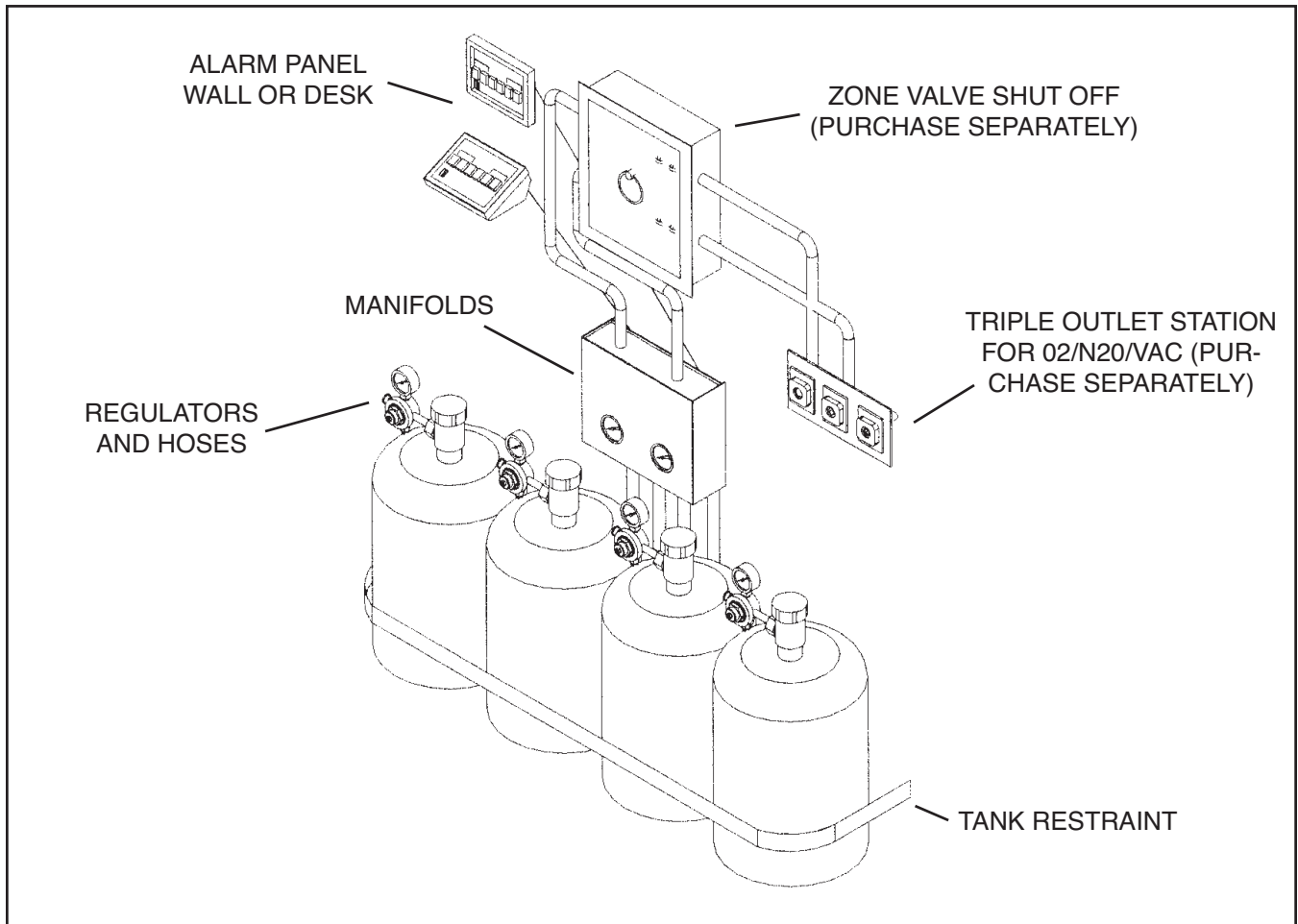

SPECIFICATIONS

Manifold Size (HxLxD)	11 1/2" x 9 1/4" x 3"
Alarm Size Wall	5" x 7" x 3/4"
Desk	5" x 7" x 4"
Relief Valve Pressure	75 PSI
Normal Working Pressure	50-55 PSI
Maximum Hose Pressure	250 PSI (1000 PSI Burst)
Hose Length	36"
Outlet Line Size - Oxygen	1/2" OD Copper
- Nitrous Oxide	3/8" OD Copper
Low Pressure Alarm Point	40 PSI
High Pressure Alarm Point	65 PSI
Primary Voltage to Alarm	12 VAC
Wire - Manifold to Alarm	50' - 5 Conductor/22 GA.
- Transformer to Alarm	30' - 2 Conductor/22 GA.
Fuse	5 x 20mm - .5 AMP
NFPA 99C - LEVEL 3 CODE COMPLIANT	

MANIFOLD SYSTEMS - 02/N20

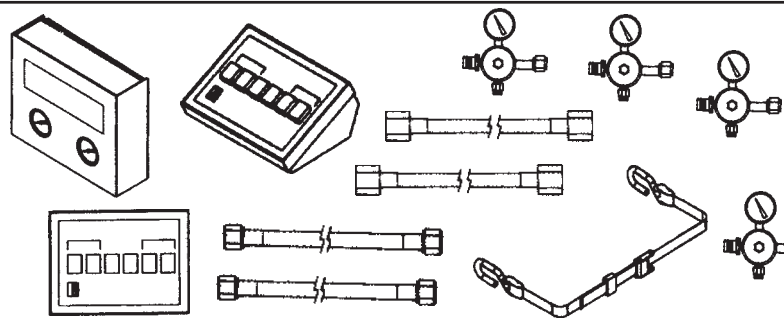
	<p>EACH SYSTEM INCLUDES APPROPRIATE MANIFOLD, ALARM WITH CABLE, REGULATORS, HOSES, CYL. RESTRAINT, INSTALLATION/OPERATIONS MANUAL, PIPELINE ID DECALS.</p> <p style="text-align: center;">2002 SYSTEM SHOWN</p>
---	---

MANIFOLD 02/N20 SYSTEMS COMPLETE			LIST
2011-W	1 + 1 CYLINDERS - WALL - ALARM		2520.00
2011-D	1 + 1 DESK		
2021-W	2 + 1 WALL		2600.00
2021-D	2 + 1 DESK		
2022-W	2 + 2 WALL		2800.00
2022-D	2 + 2 DESK		

PRE-INSTALLATION KITS

2000-W (Wall Alarm)	INCLUDES PIPELINE CONNECTORS NECESSARY WIRE AND ALARM MOUNTING ARRANGEMENT FOR WALL OR DESK STYLE ALARM		200.00
2000-D (Desk Alarm)			200.00

ZONE VALVE SHUT OFF

	4050	<p>CODE RECOMMENDED FOR REMOTE TANK ROOMS (Outside Bldgs, Different Floor Level, etc.) INCLUDES FRANGIBLE COVER, 02/N20 1/4 TURN SHUT OFFS, ALARM PRESSURE SWITCHES - 15"H x 12"W x 4"D - Designed for recessed installation - but may be surface mounted</p>	1000.00
---	------	---	---------

NOTE: ORDER OUTLET STATIONS ON PAGE 23

SYSTEM COMPONENTS

MANIFOLD SYSTEM LESS ALARM (Non-Code Compliant)			LIST
1011	1 + 1	INCLUDES MANIFOLD WITH PRESSURE SWITCHES, HOSES, REGULATORS AND TANK RESTRAINT	2000.00
1021	2 + 1		2200.00
1022	2 + 2		2400.00

ALARM KIT (RETROFIT)

3000-W (Wall Style)	INCLUDES APPROPRIATE TYPE ALARM, TRANSFORMER, WIRING AND PRESSURE SWITCHES		790.00
3000-D (Desk Style)			

02/N20 MANIFOLD - SYSTEM COMPONENTS

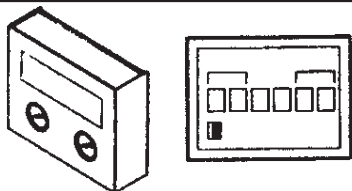
MANIFOLD AND ALARM ONLY			LIST
3022-W (Wall Style)		INCLUDES 2+2 MANIFOLD WITH PRESSURE SWITCHES, APPROPRIATE TYPE ALARM, TRANSFORMER AND WIRING	1800.00
3022-D (Desk Style)			

MANIFOLD ONLY

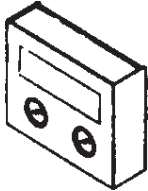
4022BA		2+2 MANIFOLD WITH PRESSURE SWITCHES	1140.00
--------	---	--	---------

MANIFOLD SYSTEM, OXYGEN ONLY

OXYGEN MANIFOLD SYSTEM, COMPLETE

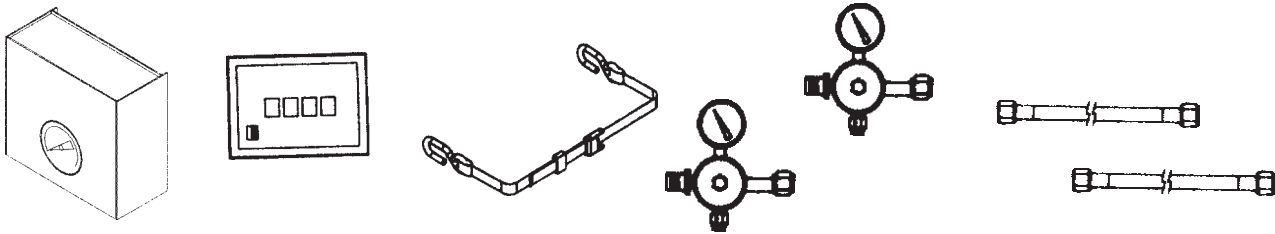
			
2020-W (Wall Alarm)	SYSTEM INCLUDES - MANIFOLD WITH PRESSURE SWITCHES FOR 2 CYLINDERS, WALL OR DESK STYLE ALARM (SPECIFY) 2 OXYGEN REGULATORS, 2-36" DISS HOSES, CYLINDER RESTRAINT, INSTALLATION/OPERATION MANUAL - PIPELINE DECALS		1980.00
2020-D (Desk Alarm)			

SYSTEM COMPONENTS - OXYGEN ONLY MANIFOLD

4020BA	02 MANIFOLD, w/PRES. SW'S. for 2 CYLS.	940.00
3200-W	02 ALARM, WALL STYLE, Incl. Alarm trans. and Wiring	700.00
3200-D	02 ALARM, DESK STYLE, Incl. Alarm, Trans., and Wiring	700.00
6001	02 REGULATOR, PRESET 50 PSI	296.00
8005x3	02 DISS HOSE, 36" - Reg. to Man	80.00
8138	CYLINDER RESTRAINT	50.00
3220-W	02 MANIFOLD AND WALL STYLE ALARM ONLY	1640.00
3220-D	02 MANIFOLD AND DESK SYTLE ALARM ONLY	1640.00

NITROGEN MANIFOLD SYSTEMS - SEE PAGE 28

NOTE: Special Gas Manifold Systems Available - Contact Factory for Price & Delivery

MANIFOLD SYSTEMS - REPLACEMENT PARTS

LIST

	8192	02 PIPELINE CONNECTOR 02 DISSNUT x 1/2" OD TUBE - 6" Lg.	60.00	
	8193	N20 PIPELINE CONNECTOR N20 DISSNUT x 3/8" OD TUBE - 6" Lg.	60.00	
	4000-602	02 GAUGE - 2" DIA 1/4" MNPT C.B. CONNECTION	60.00	
	4000-6N20	N20 GAUGE - 2" DIA 1/4" MNPT C.B. CONNECTION	60.00	
	8137	RELIEF VALVE - PRESET 75 PSI - FOR 02 OR N20	60.00	
	8138	TANK RESTRAINT 6' Lg. with EYE MOUNTING SCREWS	50.00	
	8139	CABLE, 5 CONDUCTOR - MAN. TO ALARM	1.00/Ft.	
	8140	CABLE, 2 CONDUCTOR - TRANS. TO ALARM - 02/N20 + 02 MAN. SYST.	.60/Ft.	
	8141	CABLE, 3 CONDUCTOR MAN. TO AL. - 02 ONLY MAN. SYST.	.90/Ft.	
	8190	TRANSFORMER - WALL STYLE ALARM - 12 VAC - 02/N20 & 02 SYST.	70.00	
	8191	TRANSFORMER - PLUG IN ADPT. DESK STYLE ALARMS - 12 VAC	70.00	
	7382	ALARM BULBS - 6 PAK ALL ALARMS	30.00	
	6001	REGULATOR - 02 PRESET 50 PSI - 02/N20 AND 02 SYST.	296.00	
	6002	REGULATOR - N20 - PRESET 50 PSI	296.00	
	8005X3	02 HOSE - 36" Lg. - DISS X DISS OXYGEN REG. TO MAN	80.00	
	8006X3	N20 HOSE, DISS X DISS 36" Lg - REG. TO MAN.	80.00	
	8135	MANIFOLD CHECK VALVE - 02 1/8 MNPT X 02 MALE DISS	60.00	
	8136	MANIFOLD CHECK VALVE - N20 1/4" MNPT X N20 MALE DISS	60.00	
	76059	PRESSURE SWITCH-HI (65PSI) <i>Specify Gas</i>	70.00	
	76068	PRESSURE SWITCH-LO (40PSI) <i>Specify Gas</i>	70.00	

OUTLET STATIONS, QUICK CONNECT - 02/N20/VAC

OUTLET STATION - BRAND IDENTIFICATION

FACE PLATES

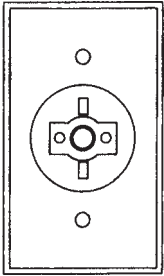

**OHIO/OHMEDA
MATRIX**

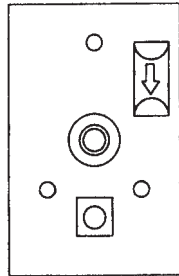

**CHEMETRON (NCG)
COASTAL
EARLY PORTER**

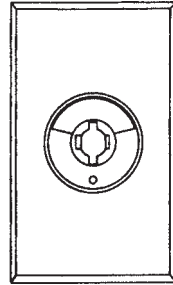

**OXEQUIP
CAMBIARE
PREVIOUSLY BELMED**

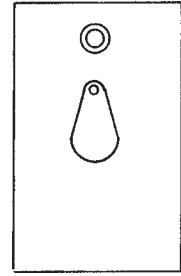

**OLDER PURITAN
FRASER
SWEATMAN
McKESSON**

BELMED, PURITAN STYLE OUTLET STATION

EXPLODED DIAGRAM OF #6500-PN CONCEALED OUTLET STATION

PIPELINES ON 2 1/2" CENTERS

N20 ALWAYS LOCATED
TO LEFT OF 02

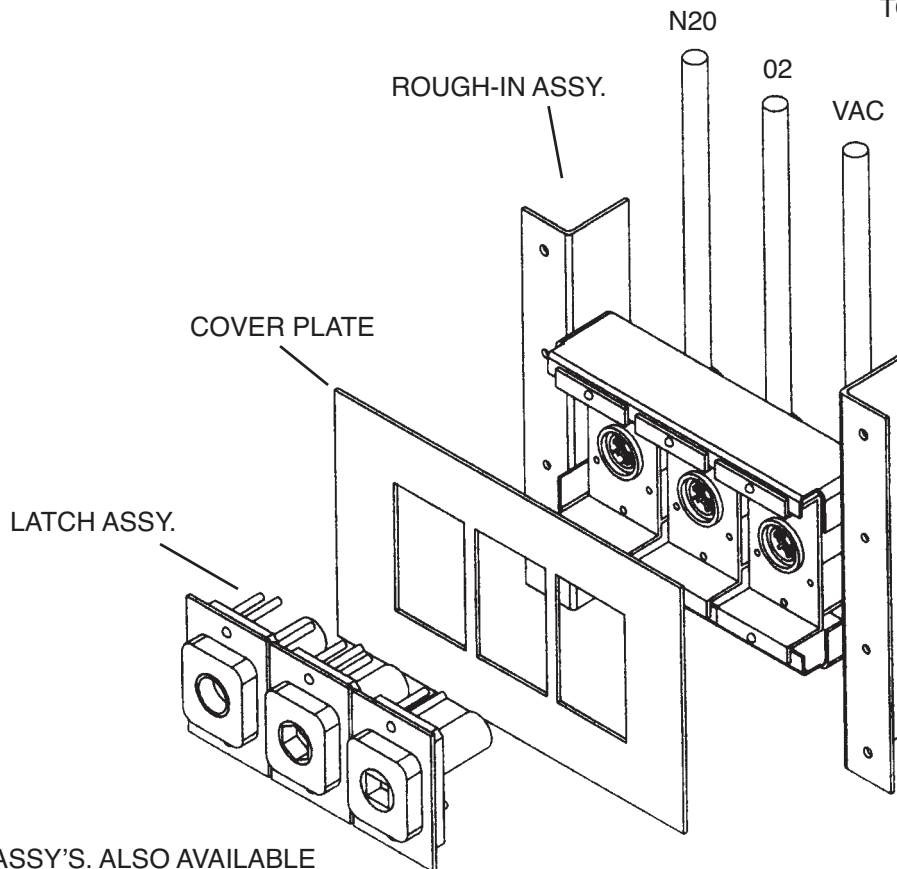

N20 OD PIPE SIZE
IS 3/8" - ALL
OTHERS 1/2" O.D.

LATCH ASSY'S. ALSO AVAILABLE
FOR OHIO (OH) AND
CHEMETRON (CN) CONNECTORS

OUTLET STATIONS - QUICK CONNECT

SINGLE OUTLET - CONCEALED (PURITAN STYLE)			LIST	DEALER
	6100-PN	NITROUS OXIDE (N20)		180.0
	6000-PN	OXYGEN (O2)		
	6200-PN	VACUUM (VACUUM)		

DOUBLE OUTLET - CONCEALED (PURITAN STYLE)

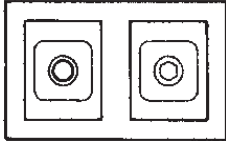
	6600-PN	NITROUS OXIDE (N20) OXYGEN (O2) VACUUM (VACUUM)	SPECIFY DESIRED GASES	296.00
---	---------	---	-----------------------------	--------

TRIPLE OUTLET - CONCEALED (PURITAN STYLE)

	6500-PN	NITROUS OXIDE (N20) OXYGEN (O2) VACUUM (VACUUM)		470.00
---	---------	---	--	--------

EXPOSED OUTLETS (PURITAN STYLE)

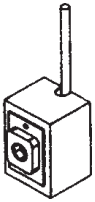
	6150-PN	NITROUS OXIDE (N20)		220.00
	6050-PN	OXYGEN (O2)		
	6250-PN	VACUUM (VACUUM)		
<p>NOTE: EXPOSED OUTLETS SOLD AS SINGLES ONLY. INSTALL MULTIPLE OUTLETS GANGED SIDE BY SIDE, PIPELINES WILL BE ON 1 9/16" CENTERS. OUTSIDE DIMENSIONS OF OUTLET: (HXWXD) 4 1/2" X 3 1/8" X 2 3/4"</p>				

OTHER BRAND OUTLETS (OHIO, CHEMETRON, OXYQUIP)

OHIO (OH)	ORDER OUTLETS FROM ABOVE 4 DIGIT NO'S. FOR SAME TYPE OUTLET (DOUBLE, TRIPLE, ETC.) SUBSTITUTE 2 LETTER DESIGNATION <u>OH</u> FOR OHIO OR <u>CN</u> FOR CHEMETRON (I.E. 6500-OH = TRIPLE CONCEALED OHIO STYLE) PRICING THE SAME AS PN OUTLETS ABOVE.
CHEMETRON (CN)	
OXYQUIP (OP)	OP LETTER DESIGNATION. AN INVENTORY OF OXEQUIP OUTLETS MAINTAINED CONTACT FACTORY FOR ORDERING INFORMATION 1-888-723-5893 (TOLL FREE)

- NITROGEN DISS OUTLETS: SEE PAGE 28
- HAND HELD (IN LINE HOSE) TYPE QUICK CONNECT- PAGE 14
- DISS STYLE OR SPECIAL GAS OUTLETS AVAILABLE - CONTACT FACTORY

**REPLACEMENT PARTS - OUTLET STATIONS, YOKE BLOCKS
BELMED OUTLETS - PURITAN, OHIO, CHEMETRON**

NOTE: SPECIFY BRAND TYPE AND GAS			LIST
LATCH PLATE ASSEMBLIES			
6010	CONCEALED OUTLET		76.00
6015	EXPOSED OUTLET		76.00
ROUGH-IN ASSEMBLIES, CONCEALED			
6011	SINGLE OUTLET		100.00
6012	DOUBLE OUTLET		200.00
6013	TRIPLE OUTLET		300.00
COVER PLATES			
6021	SINGLE, CONCEALED		30.00
6022	DOUBLE, CONCEALED		40.00
6023	TRIPLE, CONCEALED		50.00
6024	REPAIR KIT, SPECIFY ROUGH IN OR LATCH PLATE		50.00
6025	EXPOSED SINGLE (BOX) - O2, VAC, N2, N20		100.00
6026	SEAT SEALS (6/PKG.)		72.00
OXEQUIP OUTLETS			
1227-V	REBUILD KIT-VACUUM		80.00
1227-PK	ALL OTHER GASSES		80.00
1207	TUMBLER - SPECIFY GAS		80.00
1227-M	CAM PLATE		80.00
1227-2	MOUNTING RING		80.00
1217-10	SEAT SEALS (6/PKG.)		80.00
1827-1C	COVER PLATE - SINGLE - CONCEALED		40.00
1827-2C	COVER PLATE - DOUBLE - CONCEALED		60.00
1827-3C	COVER PLATE - TRIPLE - CONCEALED		80.00
YOKE BLOCKS			
5014-20	H. P. GAUGE - O2		70.00
5014-17	H. P. GAUGE - N20		70.00
5014-4	TEE HANDLE, YOKE		30.00
5014-34	TURNWHEEL HANDLE, YOKE		40.00
5014-32	CYLINDER WRENCH		24.00
5014-33	YOKE PLUGS		30.00
5014-6	CYL. SEALS (TEFZEL, WHITE) SET OF 4		20.00
5014-35	CYL. SEALS, COMPOSITE (METAL/NEOPRENE) SET OF 4		32.00



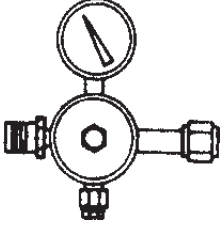
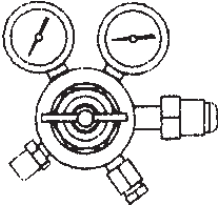
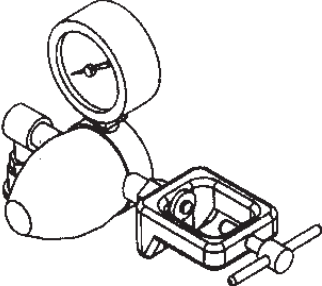
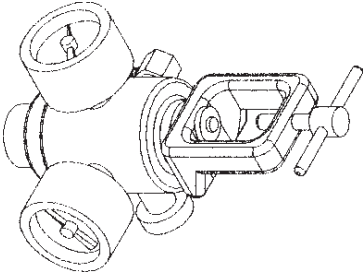

REGULATORS

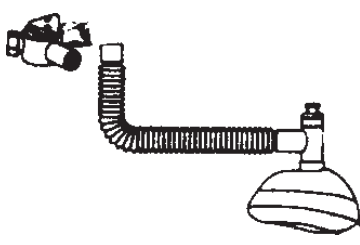
REGULATORS, FOR LARGE CYLINDERS		LIST
<p>SINGLE H.P. GAUGE - 50 PSI PRE-SET</p>  <p>6001 - OXYGEN 6002 - NITROUS OXIDE (Tank Room Manifold Regs.)</p>		296.00
<p>TWO GAUGE ADJUSTABLE PRESSURE</p>  <p>6003 - NITROGEN (O.S.) 6004 - OXYGEN 6005 - NITROUS OXIDE</p>		320.00
<p>SINGLE H.P. GAUGE - 50 PSI PRE-SET HAND-TIGHT CYLINDER CONNECTION</p> <p>6008 - OXYGEN 6009 - NITROUS OXIDE 6010 - NITROGEN</p>		358.00
REGULATORS, FOR SMALL CYLINDERS (YOKE STYLE)		
<p>SINGLE H.P. GAUGE - 50 PSI PRE-SET (YOKE)</p>  <p>6006 - OXYGEN (O2) (Demand Valve Resuscitator etc.)</p>		296.00
<p>LITER FLOW - 0-15 LPM - 2 GAUGE ADJUSTABLE (YOKE)</p>  <p>6007 - OXYGEN (O2) (Manual Type Resuscitation etc.)</p>		296.00

ORAL SURGERY EQUIPMENT

FLOWMETER "Y" SELECTOR VALVE PACKAGE			LIST
	9030	PACKAGE INCLUDES: "Y" SELECTOR VALVE BREATHING TUBE NON-REBREATHING VALVE CHILD FULL FACE MASK ADULT FULL FACE MASK	840.00



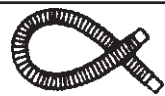

COMPONENTS - Y SELECTOR VALVE

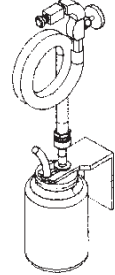
	9031	"Y" SELECTOR VALVE 22mm OD CONNECTION BY 22mm OD X 15mm ID PORTS	600.00
	9032	NON-REBREATHING VALVE POS. PRESS. THUMB BUTTON ADJUSTABLE RELIEF VALVE - 90°	196.00
	9033	CHILD FACE MASK CLEAR w/CHIN SUPPORT CUP 22mm ID CONNECTION	70.00
	9033(A)	ADULT FACE MASK	70.00
	5025	CORRUGATED BREATHING TUBE 32" LONG - 22mm CONNECTIONS	32.00

SURGICAL SUCTION - VACUUM COLLECTION UNITS

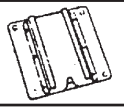
	9000-PN *NOTE: Connec- tors available for all Brand Outlet Stations - Specify Brand	INCLUDES: 1/2 GAL. COLLECTION JAR CAP ASSY. w/FLOAT FORK BRACKET WALLSLIDE PLATE VALVED ADAPTER (*PURITAN) 30" HOSE	700.00
---	--	--	--------

COMPONENTS

	9003-FPN	CAP ASSY. w/FLOAT	190.00
	9005-PN	WALL SLIDE PLATE	60.00
	9006-PN	FORK BRACKET	60.00
	9007-PN	1/2 GAL. JAR	70.00
	9008-PN	VALVED Q.C. ADAPTER - *PURITAN w/30" TUBING	196.00
	9013	REPLACEMENT CAP GASKET	30.00

ORAL SURGERY - N2 MANIFOLD SYSTEMS - RECOVERY

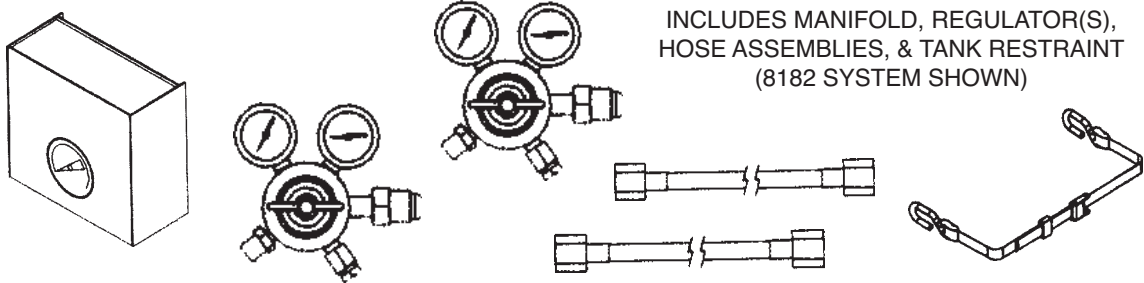
NITROGEN MANIFOLD SYSTEMS			LIST
		INCLUDES MANIFOLD, REGULATOR(S), HOSE ASSEMBLIES, & TANK RESTRAINT (8182 SYSTEM SHOWN)	
8181	N2 MANIFOLD SYSTEM FOR 1 CYL. N2		1200.00
8182	N2 MANIFOLD SYSTEM FOR 2 CYL. N2		1480.00
8183	N2 MANIFOLD SYSTEM FOR 3 CYL. N2		1800.00



N2 MANIFOLD COMPONENTS

8142	N2 MANIFOLD ONLY - 2 CYL. N2		800.00
8143	N2 MANIFOLD ONLY - 3 CYL. N2		880.00
6003	N2 REGULATOR ADJUSTABLE TO 150 PSI		320.00
8008x3	N2 TANKROOM HOSE - 3 FT. LONG		80.00
8138	TANK RESTRAINT		50.00

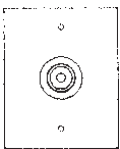

OUTLET STATION - NITROGEN D.I.S.S.

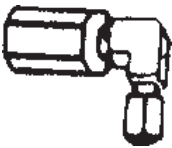
	6300D-PN	N2 DISS OUTLET - CONCEALED		200.00
	6350D-PN	N2 DISS OUTLET - EXPOSED		260.00

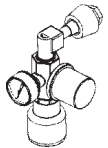



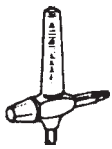

QUICK CONNECTORS FOR SURGICAL HANDPIECE

	8156	ADAPTER - STRYKER DRILL N2 DISS HAND-TITE NUT X EASTMAN Q.C. 90°		200.00
	8157	ADAPTER - HALL DRILL N2 DISS HAND-TITE NUT X SCHRADER COUPLER 90°		200.00
	8156RS	ADJUSTABLE PRESSURE REGULATOR 0-150 PSI w/GAUGE H=HALL, S=STRYKER		320.00
	8157RH			320.00

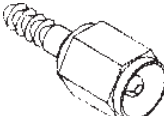
OXYGEN FLOWMETER - RECOVERY ROOM

	8160-PN	O2 THERAPY FLOWMETER 0-15 LPM x PURITAN Q.C. - AVAILABLE FOR ALL BRAND OUTLETS - SPECIFY		156.00
	8161	HIGH CONCENTRATION MASK WITH BREATHING BAG AND 7 FT. TUBING - CONNECTS TO FLOWMETER		16.00

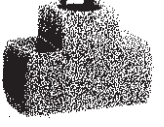
FITTINGS, CHROME PLATED - MEDICAL DISS and STANDARD PIPE

NOTE: SPECIFY MEDICAL GAS SYMBOL FOR ALL DISS FITTINGS 02: OXYGEN - N20: NITROUS OXIDE - VAC: VACUUM - N2: NITROGEN					LIST
	8020*	1/8 NPT	ADAPTER, DISS MALE x PIPE MALE SPECIFY GAS SYMBOL		40.00
	8021*	1/4 NPT			
	8125*		DISS NUT AND GLAND x 1/4 HOSE BARB SPECIFY GAS SYMBOL		40.00
 ← FLOW	8126*	1/8 NPT	ADAPTER, PRESSURE ACTIVATED CHECK VALVE DISS MALE x PIPE MALE SPECIFY GAS SYMBOL		50.00
	8127*	1/4 NPT			
 FLOW →	8128*	1/8 NPT	ADAPTER, HOSE ACTIVATED CHECK VALVE DISS MALE x PIPE MALE SPECIFY GAS SYMBOL		50.00
	8129*	1/4 NPT			
	8130-F 8130-M	1/8 NPT	HOSE ADAPTER, 1/4 HOSE BARB x PIPE FITTING F=FEMALE M=MALE		50.00
	8131-F 8131-M	1/4 NPT			
	8132*	1/8 NPT	ELBOW FEMALE PIPE SPECIFY 45° or 90°		30.00
	8133*	1/4 NPT			
	8164*	1/8 NPT	ELBOW, STREET MALE x FEMALE PIPE SPECIFY 45° or 90°		30.00
	8165*	1/4 NPT			
	8166	1/8 NPT	TEE - FEMALE PIPE		30.00
	8167	1/4 NPT			
	8147	1/8 NPT	TEE - BRANCH - FEMALE ENDS, MALE CENTER		30.00
	8148	1/4 NPT			
	8149-F 8149-M	1/8 NPT	NIPPLE. CLOSE, HEX TYPE F=FEMALE M=MALE		30.00
	8150-F 8150-M	1/4 NPT			

NOTES:



Mailing Address: P.O. Box 247 • Red Lion PA 17356-0247
Shipping Address: 887 Delta Rd. • Red Lion PA 17356
717-246-5500 • Fax: 717-246-7586



POLICIES

TERMS: Net 30 days. Accounts over 60 days past due will be placed on credit hold.

PRICES: All prices are F.O.B. Red Lion, PA, and subject to change without notice. **Minimum order \$25.00.**

WARRANTY

Definition of a Warranty Return: A product or part covered by the Belmed, Inc. warranty, that fails while the terms of the warranty are in effect.

THIS WARRANTY IS GIVEN IN PLACE OF ALL OTHER WARRANTIES, EXPRESS OR IMPLIED, OF MERCHANTABILITY, FITNESS FOR A PARTICULAR PURPOSE OR OTHERWISE.

No statement or claim about the product by any employee, agent, representative or dealer of Belmed, Inc. shall constitute a warranty by Belmed, Inc. or give rise to any liability or obligation of Belmed, Inc.

Subject to the next sentence Belmed, Inc., warrants that each product or part shall be free from defects in workmanship and materials, under normal use and with appropriate maintenance, for one (1) year from the date of delivery to customer. For plastic, rubber and disposable parts or items Belmed, Inc. warrants only that each such part and item shall be free from defects in workmanship and materials at the time of delivery to the customer.

Belmed Inc.'s obligation for breach of this warranty, or for negligence or otherwise, shall be strictly and exclusively limited to Belmed, Inc.'s choice of repair or replacement of the product or part. *This warranty shall be void for any product on which the serial number has been altered, defaced or removed.*

Belmed, Inc. shall not be liable for any damage, injury or loss arising out of the use of the product, whether as a result of a defect in the product or otherwise, if, prior to such damage, injury or loss, the product was (1) damaged, misused, or misapplied; (2) repaired, altered or modified by persons other than Belmed, Inc. (3) not installed in strict compliance with applicable codes and ordinances; or (4) not installed by Belmed, Inc. or an authorized Belmed, Inc. dealer.

UNDER NO CIRCUMSTANCES SHALL BELMED INC. BE LIABLE FOR INCIDENTAL OR CONSEQUENTIAL DAMAGES AS THOSE TERMS ARE DEFINED IN THE UNIFORM COMMERCIAL CODE.

Equipment Repair - Repair Procedures

Belmed, Inc. offers evaluation and repair service on all makes and models of analgesia equipment. We provide excellent turnaround on all products with customer approval for service-repair work. Initial inspection fee will be charged.

Shipping Procedures: Products returned for repair will be accepted without a return authorization number. Specify that it is an item for repair and marked to the attention of the Repair Service Center.

Return Goods

1. The following will NOT be accepted for credit:

- Rubber goods over 30 days old
- Rubber goods not in original, sealed package
- All hoses
- Special order items
- Goods without a Return Goods Authorization (RA)
- Merchandise more than 90 days old (from Belmed Inc. invoice date)

2. A 20% restocking charge will be deducted from the original purchase amount for all credits issued, except for return due to:

- Belmed Inc. order entry error
- Warranty returns

3. There is a minimum restocking charge of \$10.00

4. Return Authorization (RA) numbers are valid for 30 days after the date issued.

5. Freight charges will not be credited.

6. Freight collect shipments are not accepted.

7. If merchandise is found to have been misused or in any way damaged after shipment from Belmed Inc., credit will be made less charges for repair and less the 20% restocking charge. If merchandise is not salvageable, no credit will be issued.

8. All claims for damage or shortage occurring in transit must be made by the customer directly to the carrier.

Warranty Returns

1. Merchandise returned for warranty credit or replacement must have been purchased from Belmed within the specified warranty period or proof of installation within that time will be required.

2. Defective items will, at Belmed Inc.'s discretion, either be repaired or replaced with equivalent merchandise.

3. If merchandise is found to not be defective the 20% restock fee will be charged.

4. Freight charges to return defective merchandise to Belmed inc. are not reimbursable.

5. Freight charges to ship replacement or repaired merchandise to customer will be paid by Belmed Inc.

Customer Instructions - Please follow the procedures outlined below so there is no delay of credit to your account.

You must have a Return Authorization (RA) number before returning any merchandise to Belmed Inc. - except for out-or-warranty repairs for servicing. Credit may be issued only after the merchandise is returned to and inspected by Belmed Inc. and determination is made that credit is due.

To Receive a Return Authorization

1. Call your Belmed Inc. Customer Service Representative.

2. Be prepared to provide the following information:

- a. Our invoice number and date.
- b. Product description, product number, and serial number (if applicable).
- c. Reason you wish to return the merchandise.

3. Your Customer Service Representative will give you a RA number. A separate RA number will be provided for each Belmed Inc. invoice reference. The RA number authorizes our receiving department to accept the merchandise.

4. Enclose a copy of our original invoice.

5. Send the merchandise freight pre-paid.

Shortages: Any shortages or discrepancies with orders must be reported to Belmed within 5 days ARO.