

# ABRASIVES & ROTARY

# ROTARY EQUIPMENT



## MICROMOTOR

- Heavy Duty
- High Speed
- Complete with variable speed foot control
- Up to 35,000 rpm

#1530120 - Micromotor Complete

#1530161 - Handpiece only w/ 3/32" collet

#1530130 - Brushes for electric motor pk/2

#1530145 - Bearing

#1530156 - 1.5 amp fuse

#1530155 - Tool for Micromotor handpiece



## BUR CHUCK

The Bur Chuck is designed to be used with small burs and mandrels as long as they do not exceed 1/4 inch in diameter. It is to be used with lathes that have a tapered shaft. Available for the right hand side of the lathe only.

#1260050



## TAPERED CHUCK

Made of steel these chucks are designed to be used with buffing wheels, brushed, and centered wheels. The chuck is built for placement on either right or left handed shafts with a 3/8 inch or standard tapered shaft.

#1790060 - Left hand

#1790070 - Right hand

#1790010 - Male Chuck (for use in jacobs type chuck)



## PRO-LINE LATHE

New, state of the art, variable speed Pro-Line Lathe. It has the latest features that make it ideal for grinding and polishing, especially small delicate dental appliances. The unit has a 1/4 HP motor with variable rotary speeds from 500 to 3800 RPM. The Pro-Line Lathe has 1 3/8 inch tapered shaft that will fit most existing lathe accessories. This high quality piece of equipment is made in the USA and will provide years of durable service.

#9144880



## STONE CHUCK

Designed to accommodate 1/4" to 3/8" thick wheels and stones. Can be used on standard 3/8" shafts and is available for either right or left handed shafts. Made of steel for long lasting wear.

#1260070 - Left hand

#1260080 - Right hand

#1260060 - Male Chuck (for use in jacobs type chuck)



## ARBOR CHUCK

The Arbor Chuck is designed to accommodate 3/4 diameter x 3/4 inch wide abrasive bands. The female section is designed for a standard 3/8 inch shaft and the arbor chucks are available for both right and left handed sides of a lathe.

#1260030 - Left Hand

#1260040 - Right Hand

#1260020 - Male Chuck (for use in jacobs type chuck)

# DURA DIA DIAMONDS

## *new!* DURADIA

### FOR GLOSSY FINISH

- for the wet look finish on all ceramics and porcelains



1900535	1900530	1900525
Bullet Point	5/8 x .110 x 1/16	7/8 x .070 x 1/16
X-Fine	X-Fine	X-Fine

### FOR PRE-POLISHING

- leaves a gleaming surface primed for one of two final finished looks, high shine or the natural wet look - high gloss on all ceramic and porcelains



1900533	1900528	1900523
Bullet Point	5/8 x .110 x 1/16	7/8 x .070 x 1/16
Medium	Medium	Medium

### FOR FAST REMOVAL

- for fast cool reduction with little effort on all ceramics, porcelains, cercon and other zirconia based products

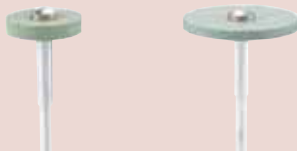

1900526	1900521
5/8 x .110 x 1/16	7/8 x .070 x 1/16
X-Coarse	X-Coarse

### FOR HIGH SHINE

- for one of the two final finished looks. Applies a high shine finish to all ceramics and porcelains

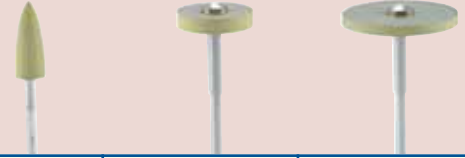

1900534	1900529	1900524
Bullet Point	5/8 x .110 x 1/16	7/8 x .070 x 1/16
Fine	Fine	Fine

### FOR SHAPING

- for fast shaping and scratch removal. leaves a satin finish on all porcelains and a final stage gloss finish on cercon



1900532	1900527	1900522
Bullet Point	5/8 x .110 x 1/16	7/8 x .070 x 1/16
Coarse	Coarse	Coarse

### DIA CUT DISCS

#### EXTRA-THIN CUTTING DISCS

- sold each



**1900566**  
3/4 x .009 x 1/16



**1900567**  
3/4 x .011 x 1/16



**1900568**  
7/8 x .015 x 1/16



**1900569**  
7/8 x .020 x 1/16

# SEPARATING DISCS & HEATLESS WHEELS

## BROWN HIGH SPEED DISC

- For those who favor the long-time standard for chrome and gold
- Aluminum oxide
- 100 per box
- 15/16" x .025" (23.8 x 0.63mm)
- #1300170



## ROUGHING DISCS

- Pk/50
- #1300670 35 x 1.7mm
- #1300680 32 x 2.2mm



## RED HEATLESS WHEELS

**NEW!**

- Ceramic coated abrasive grain that insures a smooth free cutting wheel, at the coolest temperature possible, due to the unusual micro-chipping action of the crystals as they wear
- Contains non-contaminating pure alpha aluminum oxide hexagonal crystals, with a tough ceramic coating
- Use on all non-precious and semi-precious metals
- Use on all porcelains, cercons and Lava, no need to change back to a silicon carbide wheel
- Long lasting and exhibits excellent uniform wear
- Available in the most popular Mizzy sizes: 1, 3, 5 & 8



- #6131600 #1
- #6131603 #3
- #6131605 #5
- #6131608 #8

## KEYSTONE CUT-OFF WHEELS

- Strong and durable, formulated with pure aluminum oxide abrasive
- Provide non-contaminating fast free cutting of all metals
- Reddish brown in color
- 100 per box
- 25,000 RPM
- #1900320 1-1/4" dia. x .062" (31.8 x 1.6mm) – Thick
- #1900310 1-1/2" dia. x .040" (38.2 x 1.1mm) – Medium
- #1900300 1-1/2" dia. x .025" (38.2 x 0.63mm) – Thin

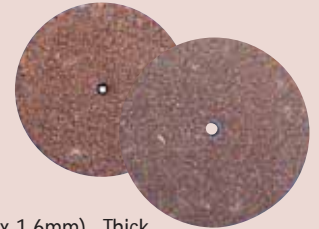

## CUT-OFF WHEELS

- Fast cutting – stronger – longer lasting
- Used for chrome cobalt and non-precious metals
- Pk/100
- #1300650 35 x 0.7mm
- #1300660 25 x 0.7mm



## MIZZY HEATLESS® WHEELS

Regular Heatless® Wheels are made of silicon carbide. A unique cooling process for the rapid reduction of plastic and metal materials.

- Bx/50

White Heatless® Wheels are made of non-contaminating, aluminous oxide and can be used on either porcelain or metal. Fast cutting, wears evenly, runs true and will not clog.

- Good for use on noble metals such as gold and platinum
- Bx/50



3/16" 1/8" 3/32"  
4.8mm 3.1mm 2.4mm



1 2 3

### White Heatless® Wheels

- # 1 - #6150100
- # 2 - #6150200
- # 3 - #6150300
- # 4 - #6150400
- # 5 - #6150500
- # 6 - #6150600
- # 7 - #6150700
- # 8 - #6150800
- # 9 - #6150900
- #10 - #6151000
- #11 - #6151100
- #12 - #6151200
- #13 - #6151300
- #14 - #6151400
- #15 - #6151500

### Regular Heatless® Wheels

- # 1 - #6130100
- # 2 - #6130200
- # 3 - #6130300
- # 4 - #6130400
- # 5 - #6130500
- # 6 - #6130600
- # 7 - #6130700
- # 8 - #6130800
- # 9 - #6130900
- #10 - #6131000
- #11 - #6131100
- #12 - #6131200
- #13 - #6131300
- #14 - #6131400
- #15 - #6131500

3/16" 1/8" 3/32"  
7/8 inch  
4.8mm 3.1mm 2.4mm



4 5 6

3/16" 1/8" 3/32"  
5/8 inch  
4.8mm 3.1mm 2.4mm



10 11 12

3/16" 1/8" 3/32"  
3/4 inch  
4.8mm 3.1mm 2.4mm



7 8 9

3/16" 1/8" 3/32"  
1/2 inch  
4.8mm 3.1mm 2.4mm



13 14 15

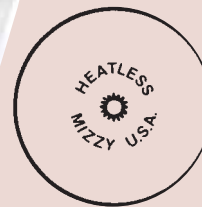



# SEPARATING DISCS

## ULTRA-FLEX DISC

- The thinnest disc available to the crown and bridge craftsman for fine cutting and finishing of interproximals and margins
  - Two-thirds as thin and more flexible than the Ultra-Thin Disc. This disc supplements the Ultra-Thin where maximum thinness is required
  - 25 per box
  - Silicon carbide - Grey color
  - 10,000-12,000 RPM
  - 7/8" x .006" (22.2 x 0.15mm)
- #1300475



## RED FLASH DISC

- The most popular and finest disc available
  - Cutoff wheel quality
  - Strong, fast and free cutting on all chrome, precious and semi-precious alloys
  - 100 per box
  - Aluminum oxide - 25,000 RPM
  - 15/16" x .025" (23.8 x 0.63mm)
- #1300430

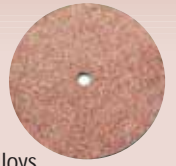

## JOE DANDY TYPE DISCS

- Pure rubber bonded silicon carbide abrasive in a special binder for fast cool cutting and finishing on porcelain, acrylic, gold, alloys and other materials
- 100 per box
- .023" (0.6 mm) Thick

	1/2"	5/8"	3/4"	7/8"	1"
	12.7 mm	15.9 mm	19 mm	22.2 mm	23.8 mm
Flat Double Cutting	1300180	1300190	1300200	1300210	1300220
Flat Safe-Sided	1300230	1300240	1300250	1300260	1300270
Cup Double Cutting		1300290	1300300	1300310	1300320



## VERI-THIN® DISC

- Much thinner than the regular Joe Dandy disc yet maintains the strength and fast cool cutting qualities. Especially suited for cutting and finishing porcelain and gold.
- Silicon carbide - Lt. grey color
  - 10,000-12,000 RPM
  - 50 per box

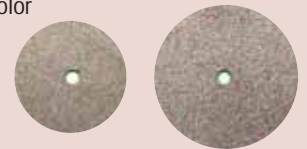

#1300450  
#1300440

7/8 x .015" (22.2 x 0.38 mm)  
3/4 x .015" (19 x 0.38 mm)



## ULTRA-THIN® DISC

- Exceptional combination of thinness, strength and cutting qualities have made this disc the indispensable industry standard for fine cutting and finishing on porcelain interproximals and margins. Pure fine silicon carbide abrasive in a unique formulation will not discolor porcelain.
- Grey Color
  - 7/8" x .009" (22.2 x 0.22mm)
  - 25 per box
  - Silicon carbide
  - 10,000-12,000 RPM
- #1300470



## DURA-THIN® DISC

- Non-contaminating companion to the Ultra-Thin Disc. Pure fine aluminum oxide abrasive especially formulated for fine cutting and finishing of ceramic metals.
- 25 per box
  - Aluminum oxide
  - 10,000-12,000 RPM
  - 7/8" x .010" (22.2 x 0.25mm)
  - Brown Color
- #1300460

# RUBBER WHEELS & POINTS

## DELUXE SILICONE POINTS & WHEELS

- Especially formulated with the finest grade of silicone
- Excellent results, long lasting, makes them cost effective
- Square Edge - 7/8 x 1/8 (22.2 x 3.1mm)
- Knife Edge - 7/8 (22.2mm)
- Box of 100

Description	Wheels Square Edge	Wheels Knife Edge	Points Bullet Point
<b>Black</b> - for all metals, medium grit	#1909000	#1909005	#1909010
<b>White</b> - for all metals, amalgam, porcelain and composites, coarse grit	#1909015	#1909020	#1909025
<b>Blue</b> - for final polish of porcelain or metals, fine grit	#1909030	#1909035	#1909040
<b>Pink</b> - for porcelain, X-fine grit	#1909045	—	#1909055

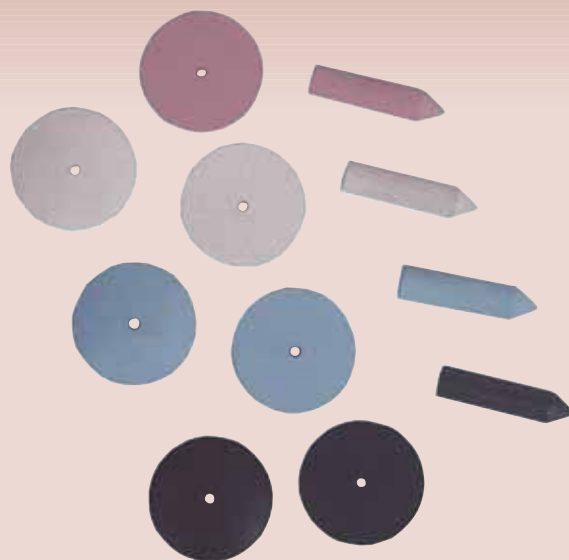

## ROUGHING DISC

- Pure coarse aluminum oxide abrasive in a heavy duty non-contaminating bond
- Provides exceptionally fast metal removal when cutting or grinding
- Free and cool cutting on all metal alloys
- 1-1/4" x .085" (31.8 x 2.2mm)
- Box of 50



#1300425

## BLACK UTILITY GRINDING WHEEL

- Excellent for trimming denture base plate materials, stone models and acrylic
- This top grade wheel is rapid cutting and will not clog at low speeds
- 46-60 grit
- Wheel has 1/4" lead reinforced center hole



#1900060 - 3 x 1/2 Black Wheel

## RED ENGINE WHEELS

- Aluminum oxide grit performs superior job on chrome or gold
- Pk/12

#1900380 - 7/8" x 1/8" Square Edge

#1900430 - 7/8" Knife Edge

#1900420 - 5/8" Knife Edge



## RUBBER ACRYLIC AND BASEPLATE WHEEL

- Coarse grit, rubber bonded wheel
- Excellent for grinding acrylic at normal lathe speed, and for baseplates at low speed
- 3" x 3/8" (76 x 9.5mm)

#1900050



## WHITE ACRYLIC KNOCK-DOWN WHEELS

- Developed for trimming base plates, acrylic, and stone models
- Aluminum oxide grit facilitates rapid shaping with minimum pressure
- Will not clog
- Generates little heat
- Wheels have 1/4" lead reinforced
- 36-46 grit
- Sold by each

#1900090 - 4" x 1/2" (101 x 12.7 mm)

#1900080 - 3" x 3/8" (79 x 9.5mm)



## PORCELAIN FINISHING DISCS

- A fine quality abrasive paper disc for finishing gold and porcelain
- 500 per box
- Sandpaper disc



## SILICON CARBIDE

	80 Grit Coarse	120 Grit Medium	220 Grit Fine	800 Grit XXX Fine
7/8"	#1300140	#1300130	#1300120	#1300110

# WHEELS & POINTS

1



## SUPERIOR RUBBER POLISHING WHEELS

7/8 x 1/8" (22.2 x 3.1 mm)/100 per box

Item No.	Description	Item No.
1900550	<b>SUPERIOR REGULAR</b> —An industry standard for years. Pure fine silicon carbide abrasive in a synthetic rubber binder combines an excellent finish on chrome with long wear. Also popular for polishing gold. Dark grey color. 240 grit.	1640010
1900560	<b>SUPERIOR HARD</b> —Same quality as SUPERIOR REGULAR only harder. Provides exceptionally long wear on chrome. Dark grey in color. 240 grit.	1640020
1900540	<b>SUPERIOR MEDIUM SOFT</b> —Pure medium grit silicon carbide abrasive in a flexible rubber binder for fast scratch-free finishing of chrome. A real production wheel. Light grey in color. 150 grit.	
1900795	<b>SUPERIOR BLUE FLEX</b> —Softer and more flexible than the "Blue Gloss". This wheel is made with a new rubber binder containing a highly friable pure fine silicon carbide abrasive. Made for both chrome and noble metals. 220 grit.	1640075
1900810	<b>SUPERIOR BLUE</b> —The popular "BLUE GLOSS" wheel improved with new polishing additives. Contains pure fine treated silicon carbide abrasive in a unique cushioned binder. Provides a lustrous finish on chrome, semi-precious and precious metals. 220 grit.	1640070
1900805	<b>SUPERIOR GREEN</b> —An "All Purpose" polishing wheel for all metals. Pure medium fine silicon carbide abrasive in a premium flexible rubber bond provides fast high quality finishing. Fast becoming an industry favorite. 180 grit.	1640060
1900800	<b>SUPERIOR BLACK</b> —Developed for fast chrome finishing, this harder but still flexible premium rubber bond with pure medium coarse silicon carbide, combines excellent finish and wear qualities. Very popular with chrome labs. 150 grit.	1640050
1900815	<b>SUPERIOR RED</b> —A specially formulated resilient binder combined with carefully graded pure fine silicon carbide abrasive provides a high quality lustrous finish on precious and non-precious metals. More flexible and not too aggressive, it is a favorite for finishing precious alloys. 240 grit.	1640080
1900816	<b>SUPERIOR HARD RED</b> —Same quality as SUPERIOR RED only harder. Provides exceptionally long wear on precious and non-precious alloys. 240 grit.	1640081
1900820	<b>SUPERIOR WHITE</b> —Non-contaminating for use on ceramic gold and porcelain. Specially formulated with pure fine aluminum oxide abrasive in a cushioned binder to provide a polished finish to porcelain. 220 grit.	
1900580	<b>SUPERIOR GREEN UTILITY</b> —Pure coarse silicon carbide abrasive in a highly flexible binder for fast, effective polishing on gold, porcelain and acrylic. 90 grit.	

2



## SUPERIOR RUBBER CLASP POLISHERS

15/16 x 1/4" (23.8 x 6.3mm)/100 per box

# DIAMONDS

## SINTERED DIAMONDS

Actual Size Shown														
	Number	1	2	3	4	5	6	7	8	9	10	11	12	13
Super	1290660	1290730	1290580	1290680	1290720	1290610	1290630	1290670	1290570	1290590	1290600	1290620	1290640	1290650
Coarse	1290665	1290735	1290585	1290685	1290725	1290615	1290635	1290675	1290575	1290595	1290605	1290625	1290645	1290655

- Lasts 100 - 150 times longer than regular stones
- Extremely high cutting efficiency
- Diamonds do not create dust – very user friendly

### Sintered Diamond Kit Available

Contains 12 of our most popular shapes  
**#1290740** - Super Coarse (Black) -  
 Chrome, Cobalt, Non-precious & Hard Metals  
**#1290745** - Coarse (Blue) - Porcelain



## DIAMOND DISCS

- Flexible Diamond Discs for the Dental Lab
- All discs are mounted and measure 7/8" dia.

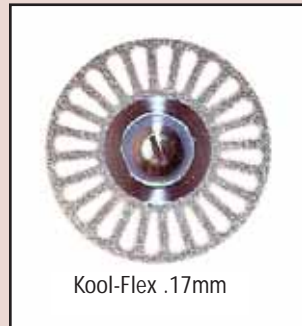

**#1290710**  
Kool-Flex .17mm  
 For use with ceramics and  
 composites (5-10,000 rpm)  
 - Double Sided



**#1290690**  
Ultra Flex .17mm  
 For use with ceramics and  
 composites. (5-10,000 rpm)  
 - Single Sided



**#1290715**  
Multi-Flex .17mm  
 For use with ceramics,  
 composites and acrylics.  
 (10-20,000 rpm)  
 - Double Sided

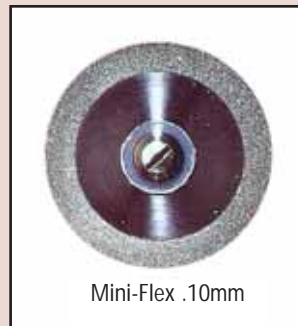

**#1290695**  
Mini-Flex .10mm  
 For use with ceramics  
 composites and acrylics.  
 (5-10,000 rpm)  
 - Double Sided

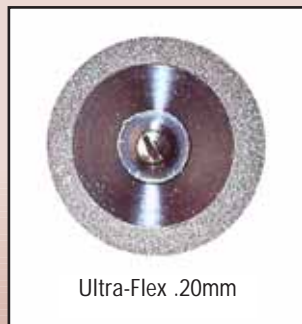

**#1290700**  
Ultra-Flex .20mm  
 For use with ceramics.  
 (10-20,000 rpm)  
 - Double Sided



**#1290705**  
AI-Flex Full Cover .20mm  
 For use with ceramic,  
 plaster and acrylic veneers.  
 (10-20,000 rpm)  
 - Double Sided



## MIZZY FLEXIS DIAMOND DISCS

- Flexible and versatile
- For forming crown edges
- For reducing crown borders to correct size before porcelain firing
- For constructing and shaping of acrylic and ceramic surfaces
- For perfect finishing of the interdental area with bridges
- Ideal RPM is 8,000 - 10,000
- Not to be used as a separating disc
- PK/8 plus 1 mandrel



- #1300610 - Black (Coarse)
- #1300620 - Red (Medium)
- #1300630 - Green (Fine)
- #1300640 - White (X-Fine)
- #1300600 - Assortment (2 of each grain size, plus 1 mandrel)

## MIZZY MINT FLAVORED DIAMOND POLISH

- Formulated to polish all restorative materials to a "glaze" high shine in seconds
  - Recommended for restoring the glaze finish on ground porcelain, tooth or composite surfaces
  - High shines all precious or non-precious metals to a smooth mirror finish
- #6121400



## TI-COATED DIAMOND DISCS

- Titanium Nitrate Coated Diamond Discs
- Sold by each with one mandrel



- Super Plaster**  
(.014) 30mm dia. Double Sided
- Used for cutting plaster, ceramics and acrylics
- #1290805 - Single Pack  
#1290806 - Double Pack



- Super Flex Coarse**  
(.014) 22mm dia. Double Sided
- Very thin and flexible. Used for light contouring and working in interproximal slots - Not for cutting
- #1290825 - Single Pack  
#1290826 - Double Pack



- Contour Perforated Coarse**  
(.014) 22mm dia. Double Sided
- Used for contouring ceramics and acrylics
- #1290820 - Single Pack  
#1290821 - Double Pack



- Sep Flex Fine**  
(.007) 22mm dia. Double Sided
- Used for separating and contouring of metals, ceramics and acrylics
- #1290775 - Single Pack  
#1290776 - Double Pack



- Contour Perforated Fine**  
(.014) 22mm dia. Double Sided
- Used for contouring ceramics and acrylics
- #1290800 - Single Pack  
#1290801 - Double Pack



- Sep Flex Fine**  
(.006) 22mm dia. Single Sided
- Used for separating ceramics, metals and acrylic
- #1290780 - Single Pack  
#1290781 - Double Pack



- Cut Flex Coarse**  
(.014) 22mm dia. Double Sided
- Used for cutting ceramics and acrylics and can be used for heavier cutting
- #1290810 - Single Pack  
#1290811 - Double Pack



- Sep Flex Coarse**  
(.007) 22mm dia. Double Sided
- Used for separating and contouring of ceramics, metals, plaster and acrylic
- #1290815 - Single Pack  
#1290816 - Double Pack



- Cut Flex Fine**  
(.007) 22mm dia. Double Sided
- Used for separating ceramics and acrylic
- #1290790 - Single Pack  
#1290791 - Double Pack

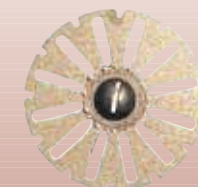

- Top Flex Perforated Fine**  
(.007) 22mm dia. Double Sided
- Used for contouring ceramics
- #1290795 - Single Pack  
#1290796 - Double Pack

# HABRAS DISCS & HATHO SETS

## HABRAS DISCS

Habras Discs, manufactured by 3M™, offer you a unique, three-dimensional abrasive/flexible bristle design that provides a uniform finish. These discs are ideal for heavy cleaning (coarse), removing light oxide (medium), pre-polishing, semi-finishing, blending, texturizing and polishing (fine). Habras Discs provide the convenience of a pre-charged abrasive but do not generate the heat associated with rubber wheels. Embedded cubitron mineral abrasive is much harder than most metal. Removes oxides and polish without using compounds. Ideal for cleaning metal work and hard-to-reach areas. 10,000 RPM. 19 mm dia.

Recommended: 4 discs mounted together. **#1670113** - Habras Disc Kit (4 discs of each grit mounted on mandrel)



	Coarse	Medium	Fine	Super Fine	High Gloss	High Polishing
	Yellow - 80 grit	Red - 220 grit	Blue - 400 grit	Pink - Pumice	Orange - 6µ	Green - 1µ
Pk/4 w/Mandrel	<b>#1670083</b>	<b>#1670084</b>	<b>#1670085</b>	<b>#1670086</b>	<b>#1670107</b>	<b>#1670108</b>
Pk/4 w/o Mandrel	<b>#1670097</b>	<b>#1670098</b>	<b>#1670099</b>	<b>#1670100</b>	<b>#1670111</b>	<b>#1670112</b>
Pk/48 w/o Mandrel	<b>#1670101</b>	<b>#1670102</b>	<b>#1670103</b>	<b>#1670104</b>	<b>#1670115</b>	<b>#1670116</b>

## TITANIUM POLISHING SET

Polishing set for efficient high-shine polishing of titanium crown and bridge work and implant construction.

- 2 Miniature Polishing Brushes with grey goat hair and microfiber leather to polish occlusal surfaces
- Diamond Paste (2.5 gm) for creating a high shine on titanium
- 2 Miniature Buffs with felt cloth for polishing implant supra constructions
- 2 Miniature Buffs with fine cotton to give a high shine

**#1670134**



## ACRYLIC POLISHING SET

Polishing set for efficient high-shine polishing of acrylic dentures and teeth.

- 2 Poly-Buffs Chung King Lathe Brushes with Scotch Brite™ for pre-polishing with pumice
- 1 Microfiber leather Buff for high shine polishing with Hatho beige paste
- 1 Hatho Beige Polishing Paste (100 gm) for high shine polishing
- 1 Cotton Buff for high shine polishing of acrylic without paste

**#1670133**



## POLISTAR POLISHING SET

Polishing set for an efficient high-shine polishing of acrylic dentures and teeth.

- 300 g Polistar Lintgrey
- 125 ml Polistar Emulsion
- 1 Cotton Buff

**#1670200**



**NEW!**

# ROTARY PRODUCTS

## ABBOTT ROBINSON BRUSHES



- |                                 |                                 |
|---------------------------------|---------------------------------|
| #1170010 – #9 Soft-gross        | #1170051 – #11 Std. Stiff-dozen |
| #1170011 – #9 Soft-dozen        | #1170080 – #11 Ex. Stiff-gross  |
| #1170040 – #9 Std. Stiff-gross  | #1170081 – #11 Ex. Stiff-dozen  |
| #1170041 – #9 Std. Stiff-dozen  | #1170030 – #12 Soft-gross       |
| #1170070 – #9 Ex. Stiff-gross   | #1170031 – #12 Soft-dozen       |
| #1170071 – #9 Ex. Stiff-dozen   | #1170060 – #12 Std. Stiff-gross |
| #1170020 – #11 Soft-gross       | #1170061 – #12 Std. Stiff-dozen |
| #1170021 – #11 Soft-dozen       | #1170090 – #12 Ex. Stiff-gross  |
| #1170050 – #11 Std. Stiff-gross | #1170091 – #12 Ex. Stiff-dozen  |

## LATHE BRUSHES

- Top Quality Chung King Bristle
- Pk/12



B12 1 <sup>7</sup> / <sub>8</sub> " dia. 2 Rows - Converging Bristle	#1170180 - Plastic Hub	#1170100 - Wood Hub
B14 2" dia. 2 Rows - Converging Bristle	#1170190 - Plastic Hub	#1170110 - Wood Hub
B20 2 <sup>1</sup> / <sub>2</sub> " dia. 2 Rows - Converging Bristle	#1170200 - Plastic Hub	#1170120 - Wood Hub
B23 2 <sup>3</sup> / <sub>4</sub> " dia. 3 Rows - Converging Bristle		#1170130 - Wood Hub
B24 2 <sup>1</sup> / <sub>2</sub> " dia. - Extra Stiff 3 Rows - Semi Converging	#1170210 - Plastic Hub	#1170170 - Wood Hub
B25 2 <sup>3</sup> / <sub>4</sub> " dia. 3 Rows - Upright Bristle		#1170140 - Wood Hub
B27 3" dia. 4 Rows - Converging Bristle		#1170150 - Wood Hub
B29 3" dia. 4 Rows - Upright Bristle		#1170160 - Wood Hub

## ECONO CUTTERS

- May be used at speeds up to 24,000 rpm
- .035 thick

- #1300480 - 2-1/2" dia.
- #1300500 - 4" dia.
- #1300490 - 1-1/2" dia.

Special mandrel required for 2-1/2" dia and 4" dia. Econo Cutters  
#1300510 - Econo Cutter Mandrel

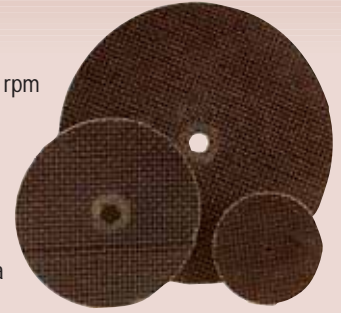

## WATERPROOF MODEL TRIMMER DISCS

These superior quality coated abrasive discs will cut models three to four times faster than most discs now in use. Reduces noise by 75%. Available in two sizes. Backing plates and plastic washers available.



- #1900640 - Complete 10" set includes six discs, backing wheel and washer
- #1900650 - Replacement set of six 10" discs only
- #1900660 - 10" plastic backing wheel
- #1900670 - Plastic washer for 10" and 12" discs
- #1900680 - Complete 12" set includes four discs, backing wheel and washer
- #1900690 - Replacement set of four 12" discs only
- #1900695 - 12" refill, pk/25
- #1900700 - 12" plastic backing wheel

## CARBO MODEL TRIMMER WHEEL

Our carborundum model trimmer wheels are reversible and available in two sizes.

- #1900620 - 10" x 1/4" x 1", for Handler, Torit, Buffalo, Foster and Tooth Master units. Coarse, 1 hole
- #1900630 - 12" x 1/4" x 1", Coarse, 1 hole
- #1900635 - 12" x 1/4" x 1", Coarse wheel for Foster unit only. 2 hole



## DIAMOND COATED MODEL TRIMMER WHEEL

Cuts faster, smoother, and quieter. Self cleaning. Made on space-age composite backing. Will not warp or corrode like aluminum. Diamond is bonded to backing. Single Sided.

- #1900642 - 10"
- #1900645 - 12"





# ABRASIVES & ROTARY INSTRUMENTS

## FIELD ROLL MANDRELS

- #1730020 - 1/4" shank for No. 3 Roll
- #1730040 - 1/4" shank for No. 4 Roll
- #1730050 - 1/4" shank for No. 5 Roll
- #1730060 - 1/4" shank for No. 6 Roll
- #1730070 - 3/32" shank for No. 7 Roll

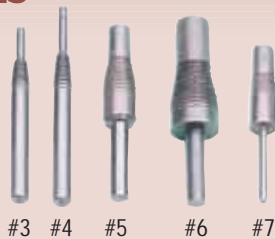

## ARBOR BAND MANDREL

- Quality arbor band mandrels for 1/4", 3/8", 1/2", and 3/4" arbor bands. 3/32" shank.



- #1520010 - 1/4"
- #1520020 - 3/8"
- #1520030 - 1/2"
- #1520035 - 3/4"

### Rubber Head only

- #1502500 - 1/4"
- #1502505 - 3/8"
- #1502510 - 1/2"
- #1502515 - 3/4"

## HEAVY BONDED ARBOR BANDS

- Labor saving & Long Lasting
- Available in 3/8" and 3/4" diameters only
- Coarse grit
- Boxes of 100 or 500



- #1090390 - 3/8" Box/100
- #1090400 - 3/8" Box/500

- #1090370 - 3/4" Box/100
- #1090380 - 3/4" Box/500

## HIGH SPEED MANDRELS

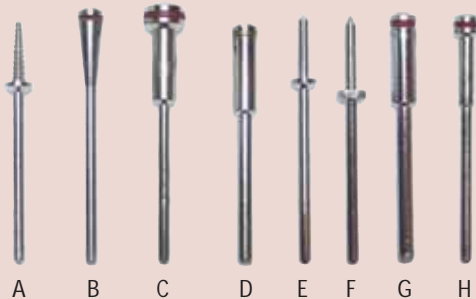

- #1520041 - (A) Mandrel Corkscrew 3/32" Shank, Dozen
- #1520040 - (A) Mandrel Corkscrew 3/32" Shank, Gross
- #1520056 - (B) Tapered Handpiece Mandrel, Dozen
- #1520055 - (B) Tapered Handpiece Mandrel, Gross
- #1520090 - (C) Mandrel 3/32" Shank, 1/16" Screw 8mm large head, Dozen
- #1520185 - (C) Mandrel 3/32" Shank, 1/16" Screw 8mm large head, Gross
- #1520061 - (D) Mandrel, Heavy Duty 1/8" Shank, 1/16" Screw, Dozen
- #1520060 - (D) Mandrel, Heavy Duty 1/8" Shank, 1/16" Screw, Gross
- #1520071 - (E) Mandrel, Spiral 3/32" Shank, Dozen
- #1520070 - (E) Mandrel, Spiral 3/32" Shank, Gross
- #1520081 - (F) Mandrel, Spiral w/Hex Nut 3/32" Shank, Dozen
- #1520080 - (F) Mandrel, Spiral w/Hex Nut 3/32" Shank, Gross
- #1520091 - (G) Mandrel, Heavy Duty 1/8" Shank, 1/8" Screw, Dozen
- #1520095 - (G) Mandrel, Heavy Duty 1/8" Shank, 1/8" Screw, Dozen
- #1520051 - (H) Mandrel, HP High Speed Reinforced 3/32" Shank 1/16" Screw, Dozen
- #1520050 - (H) Mandrel, HP High Speed Reinforced 3/32" Shank 1/16" Screw, Gross

## FIELD ABRASIVE ROLL

- Field's "Strongstitch" Abrasive Rolls, available in 60 grit (coarse)
- Other grits available upon request

- #3 (1/2" dia. x 3/4" ht. x 5/32" hole)
- #1720010 - 100/bx
- #1720020 - 1000/bx

- #4 (1/2" dia. x 1" ht. x 5/32 hole)
- #1720050 - 100/bx
- #1720060 - 1000/bx

- #5 (3/4" dia. x 1" ht. x 5/16 hole)
- #1720070 - 100/bx
- #1720080 - 1000/bx

- #6 (13/16" dia. x 1" ht. x 7/16 hole)
- #1720090 - 100/bx
- #1720100 - 1000/bx

- #7 (1/2" dia. 3/4" ht. x 5/16 hole)
- #1720030 - 100/bx
- #1720040 - 1000/bx



## ARBOR BANDS



- #1090340 - 1/4" Coarse, 60 grit, 100/bx
- #1090360 - 1/4" Coarse, 60 grit, 1000/bx
- #1090250 - 3/8" Coarse, 60 grit, 100/bx
- #1090270 - 3/8" Coarse, 60 grit, 1000/bx
- #1090160 - 1/2" Coarse, 60 grit, 100/bx
- #1090180 - 1/2" Coarse, 60 grit, 1000/bx
- #1090070 - 3/4" Coarse, 60 grit, 100/bx
- #1090090 - 3/4" Coarse, 60 grit, 1000/bx

- #1090310 - 1/4" Medium, 80 grit, 100/bx
- #1090330 - 1/4" Medium, 80 grit, 1000/bx
- #1090220 - 3/8" Medium, 80 grit, 100/bx
- #1090240 - 3/8" Medium, 80 grit, 1000/bx
- #1090130 - 1/2" Medium, 80 grit, 100/bx
- #1090150 - 1/2" Medium, 80 grit, 1000/bx
- #1090040 - 3/4" Medium, 80 grit, 100/bx
- #1090060 - 3/4" Medium, 80 grit, 1000/bx

- #1090280 - 1/4" Fine, 120 grit, 100/bx
- #1090300 - 1/4" Fine, 120 grit, 1000/bx
- #1090190 - 3/8" Fine, 120 grit, 100/bx
- #1090210 - 3/8" Fine, 120 grit, 1000/bx
- #1090100 - 1/2" Fine, 120 grit, 100/bx
- #1090120 - 1/2" Fine, 120 grit, 1000/bx
- #1090010 - 3/4" Fine, 120 grit, 100/bx
- #1090030 - 3/4" Fine, 120 grit, 1000/bx

# BUFFS & POLISHING WHEELS

## LEATHER CENTER BUFFS

- A leather center produces a buff which is very rigid on a tapered spindle
- Quality muslin material
- Sold per dozen
- #1180100 - 3" x 35 ply
- #1180110 - 4" x 40 ply



## CHAMOIS BUFFS

- Top quality stitched, leather center chamois buffs
- Produces a very high luster
- 12 ply
- #1180040 - 2-1/2" x 1/2" (sold individually)
- #1180030 - 3" x 1/2" (sold individually)
- #1180050 - 1" (12 pk)



## LEAD CENTER BUFFS

- Quality muslin plies with lead center for rigidity
- Sold per dozen
- #1180080 - 3" x 36 ply
- #1180090 - 4" x 36 ply



## FLANNEL BUFFS

- High quality flannel
- Virtually lint free
- Used with fine rouge to produce a final high luster on gold or acrylic
- May also be used as a wipe off wheel without composition
- Sold individually
- 20 ply
- #1180065 - 3"
- #1180075 - 4"



## MUSLIN BUFFS

- Carefully selected material, each ply is a full cut
- Stitching is uniform and will not pull out
- Sold per dozen
- #1180120 - 2" x 30 ply
- #1180130 - 3" x 24 ply
- #1180135 - 3" x 30 ply
- #1180140 - 3" x 35 ply
- #1180150 - 4" x 24 ply
- #1180160 - 4" x 30 ply
- #1180170 - 4" x 42 ply
- #1180180 - 5" x 30 ply
- #1180190 - 5" x 45 ply
- #1180200 - 6" x 30 ply



## BABY MUSLIN BUFFS

- Ideal for polishing small and difficult-to-reach areas
- 16 Ply
- #1180010 - 1" dia. Pkg. 50
- #1180015 - 1" dia. Pkg. 100
- #1180020 - 1-1/2" dia. Pkg. 50
- #1180025 - 1-1/2" dia. Pkg. 100



## HATHO POLISHING WHEELS

- Scotch Brite™ great for thermal plastic soft liners.
- Saves time & money

### Mounted (1" diameter) Scotch Brite™ Brushes

Mounted on mandrel. Same application as polishing discs with Scotch Brite™. Pk/12



Coarse 5000 rpm #1670016	Medium 5000 rpm #1670092	Fine 5000 rpm #1670091
--------------------------------	--------------------------------	------------------------------

### Unmounted Scotch Brite™ Wheels

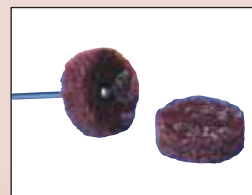

1.25" Round  
(12 each w/ mandrel)  
#9631230

3" Round  
#9631210

### Miniature Polishing

Coarse, normal thickness



8000 rpm  
#1670023  
Pk/12

### Miniature Brush

with polishing discs



White Goat  
Hair with  
chamois

Gray Goat  
Hair with  
chamois

10,000 rpm  
#1670051  
Pk/12

10,000 rpm  
#1670052  
Pk/12



# KEY GOLD & CARBIDE BURS

## KEYGOLD

- Coated with gold colored Titanium Nitride
- High speed - faster cutting - longer lasting

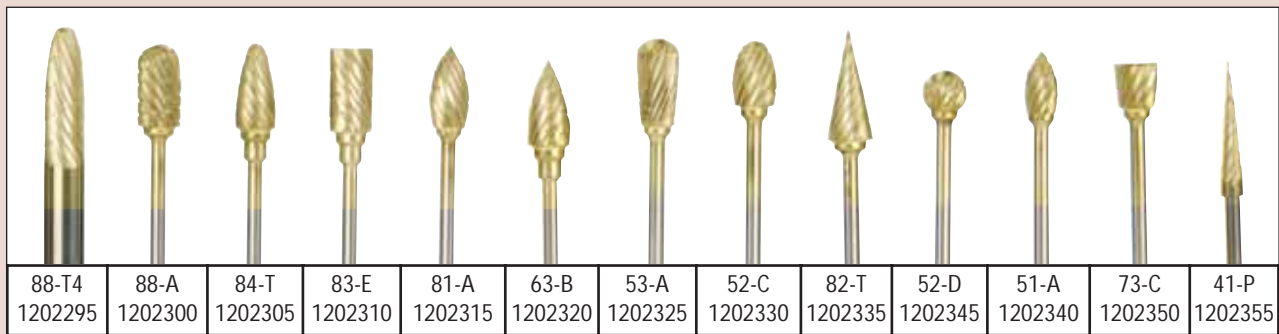
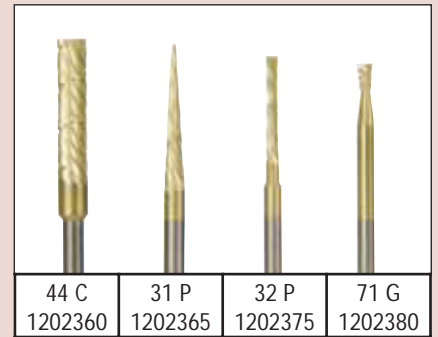

## CARBIDE BURS

- Spiral Cut
- Precision burs that require less pressure and cut smoothly with minimum heat
- Hand ground to insure quality control



# MOUNTED POINTS & STONES

## GREEN MOUNTED STONES

Finest quality silicon carbide grit, fast & cool cutting, economical to use, excellent durability and 14 popular shapes. Guaranteed to meet your porcelain, composite, gold and silver finishing requirements.

- Sold per dozen
- 3/32" Shank



## RED MOUNTED POINTS

For years, the standard point for chrome processors. Available in handpiece only.

- 3/32" Shank
- Sold per dozen



## BLUE MOUNTED POINTS

Used for finishing chrome alloys and non-precious metal, hold their shape, fast cutting and long lasting.

- Made of aluminum oxide
- Bx/100



## PINK & WHITE MOUNTED POINTS

Made of non-contaminating aluminum oxide. Pink used for precious ceramic metals. White used for non-precious ceramic metals.

- 3/32" Shank
- Box of 72



