

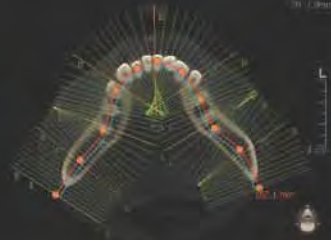

R



MR

10 / 2000

L

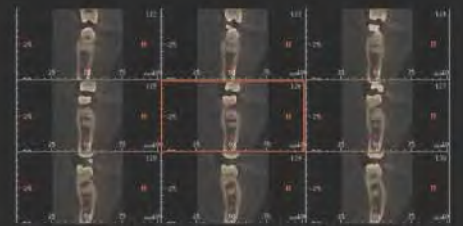

PaX-i3D

Your First Partner for
3D Diagnosis



Your First Partner for 3D Diagnosis, PaX-i3D

with the next generation of PaX-Duo3D Plus

1

Optimal FOV Sizes for 3D Diagnosis

- Increase your diagnosis and treatment accuracy.
- Multi FOV sizes range from 5x5 to 12x9

2

Special SW for Specialists

- Analyze 3D images with advanced tools and functions.
- Ez3D supports effective and efficient communication with your patients.

3

Wide Range of Ceph Modes

- Scan Type: LAT / Full LAT
- One Shot Type: Small / Medium / Large

4

Magic PAN

- It brings you the best optimized panoramic image.
- Magic PAN applies to all areas of the image.



POWERFUL DIAGNOSTIC VALUE WITH 3D IMAGES

FLEXIBLE 3D IMAGING WITH MULTI FOV SELECTION

PaX-i3D provides 4 multi FOV sizes ranging from 5x5 to 12x9.

By selecting the appropriate FOV size, you can have the optimum image for your diagnostic needs reducing unnecessary X-ray radiation for patients.

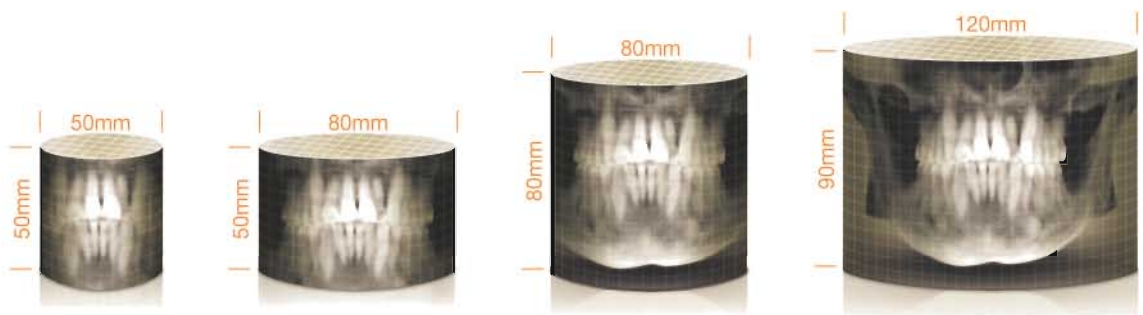

FOV 5X5

5X5 scans are useful for a specific area diagnosis with minimum X-ray exposure for patients. It can especially increase the accuracy of endodontic diagnosis by exactly checking the amount of root canals and abnormal root canal shapes such as C-shapes that are difficult to check using a 2D X-ray system.

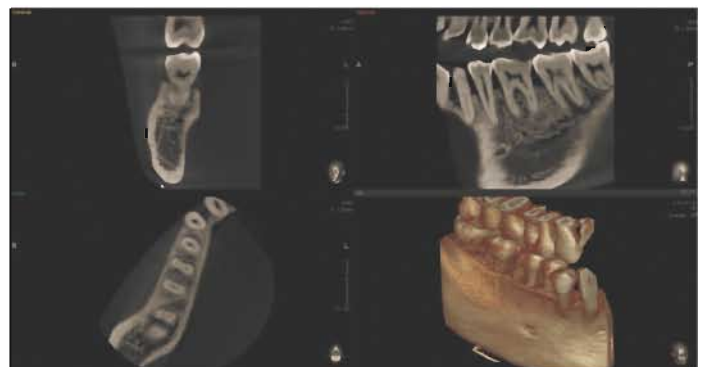

FOV 8X5

8X5 scans can provide more extended oral information on maxillary or mandibular areas. An accurate treatment plan can be established by taking into account the major anatomical structures like mandibular nerve, mental foramen or maxillary sinus.

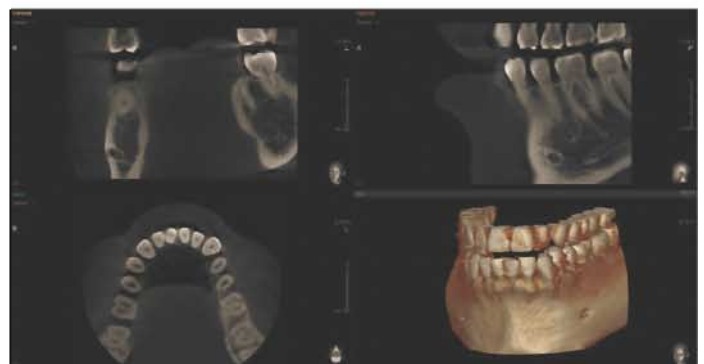

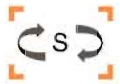
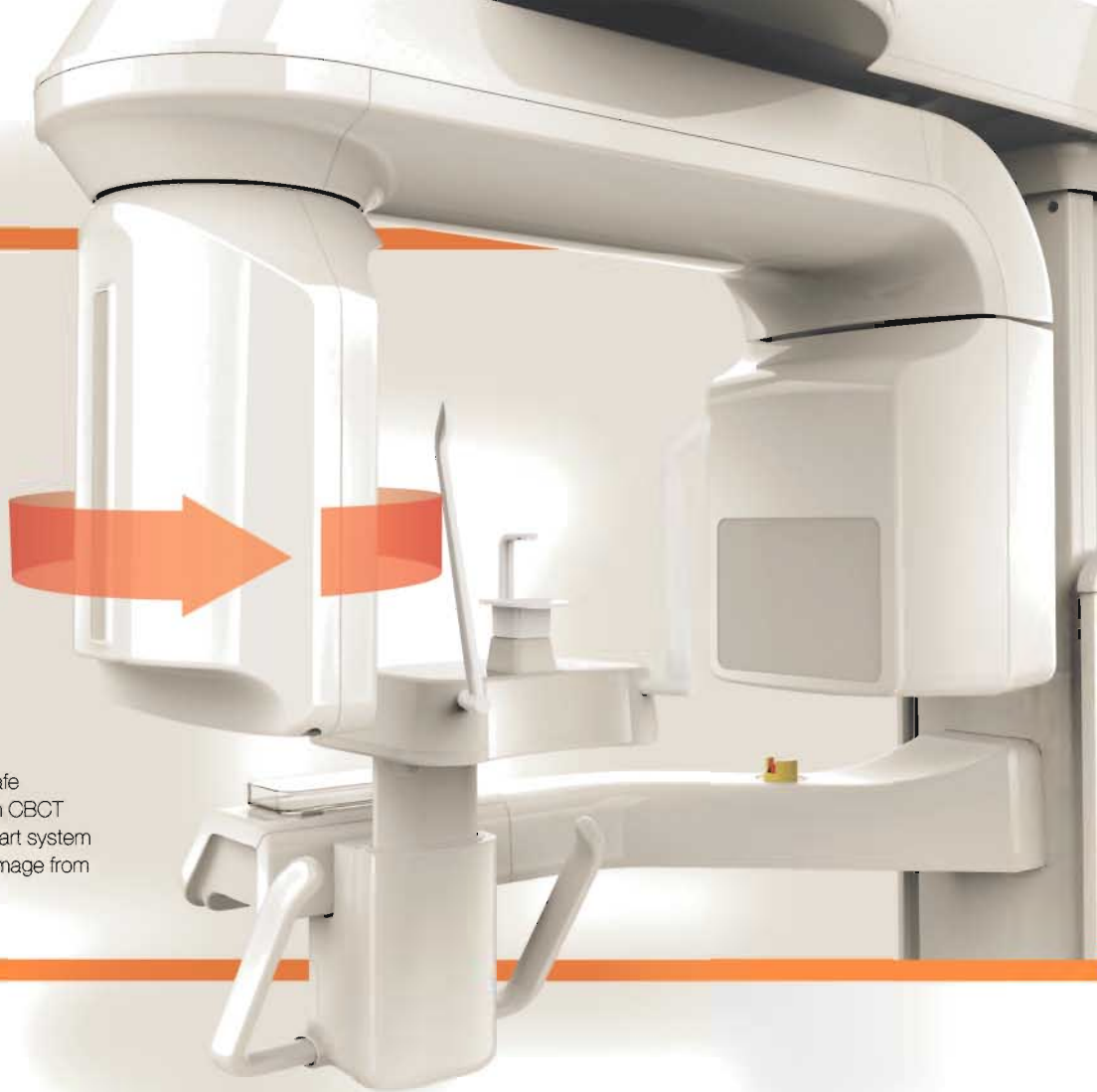

AUTO-SWITCHING

PaX-i3D offers convenient and safe 'Auto-Switching' system between CBCT and Panoramic sensors. This smart system conveniently prevents sensor damage from accidental dropping.

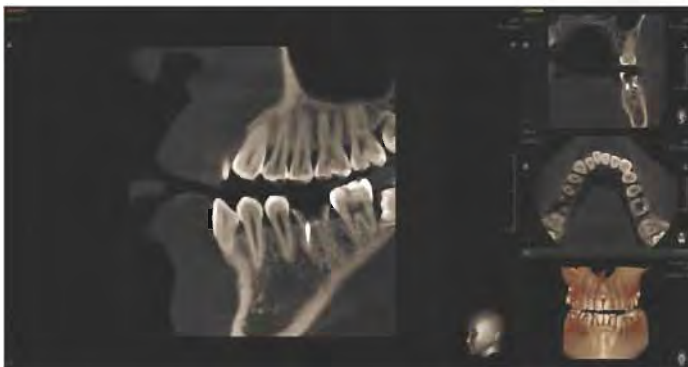

FOV 8X8

8X8 scans enable comprehensive diagnosis and treatment planning including both maxillary and mandibular areas in a single scan. It is useful for complex implant surgery as well as left or right TMJ diagnosis.



FOV 12X9

12X9 scans can provide the most optimal information for oral diagnosis, fully covering both maxillary and mandibular structures including the 3rd molar region in a single scan. It is suitable for most oral surgery cases as well as multiple implant surgery.



POWERFUL DIAGNOSTIC VALUE THE HIGHER, FASTER, EASIER 3D EXPERIENCE

Ez3D Plus is a dental imaging software for PCs that provides accurate and fast diagnosis through 3D visualization, 2D analysis, and various MPR functions to manipulate CT images in a DICOM format. The professional version of Ez3D Plus includes more diverse functions, including canal tracing, implant simulation, and bone density profiling of the area surrounding the implant.

1 Menu Bar

All functions of Ez3D Plus are provided in a pull down menu classified by category.

2 Tool Bar

The tool bar provides the user with the most commonly used tools among the menu functions.

3 View Mode

View Mode consists of MPR, Oblique, 3D Zoom, Curve, Cephalo and TMJ mode.

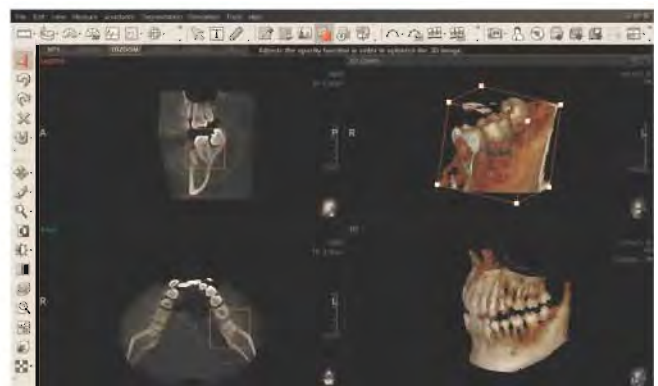
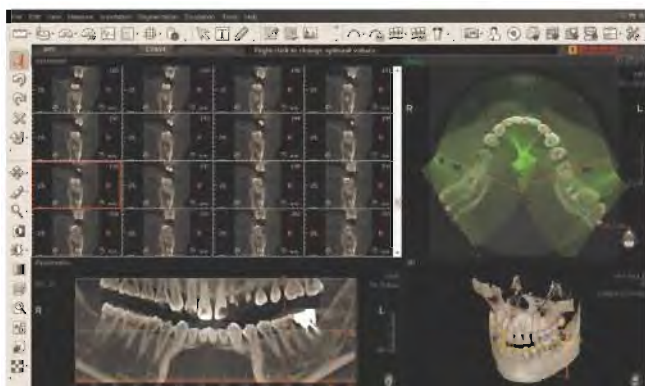
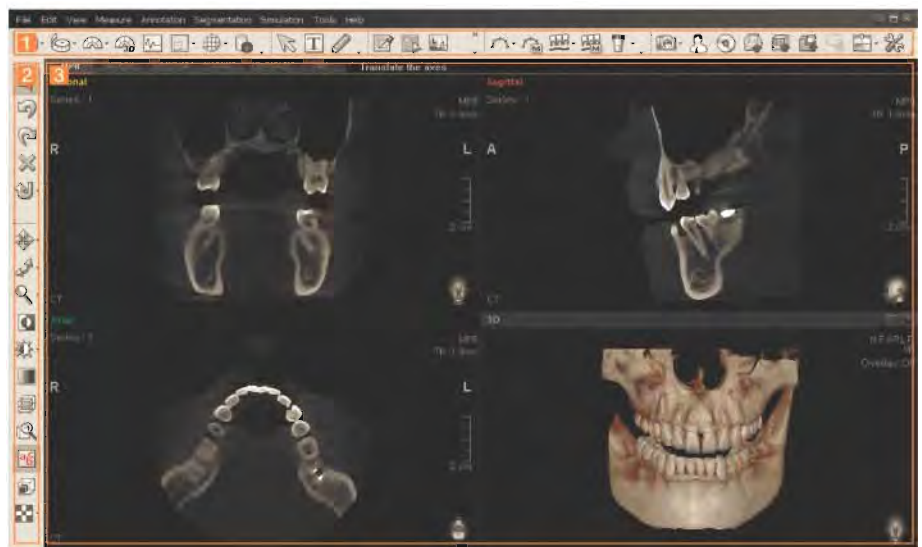



Profile

Profile function displays bone density ensuring optimal implant placement.

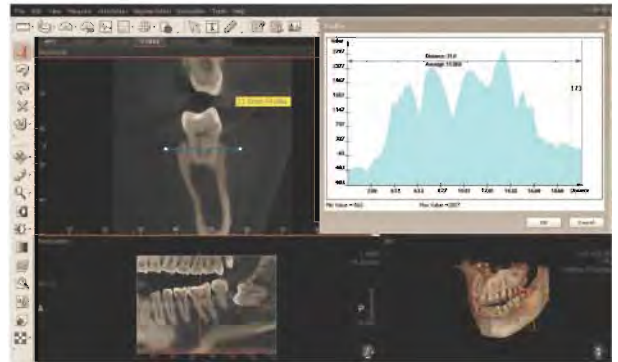

Implant Simulation

Implant simulation function reduces the risk during surgery and allows simple and accurate planning without complicated process.

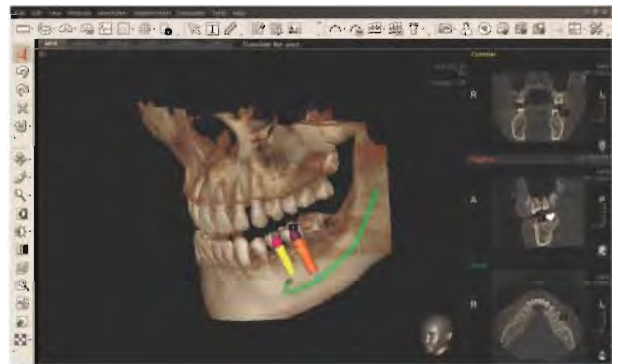

3D Zoom

For more details, you can use the 3D Zoom function. It gives you detailed information of ROI (Region of Interest).

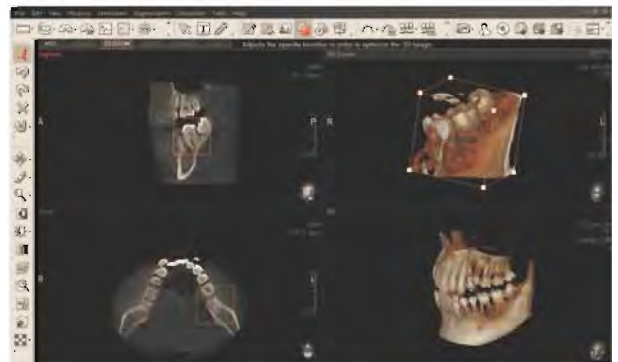

Oblique

Oblique function simplifies the ability to generate a 360 degree view around a specific region of interest.

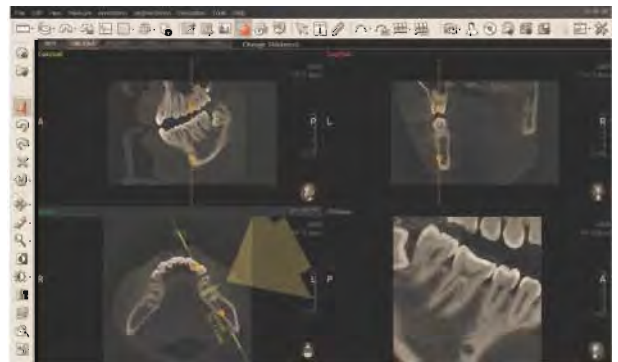

POWERFUL DIAGNOSTIC VALUE WITH CEPHALOMETRIC IMAGES

EXTENDED DIAGNOSTIC VALUE FOR WIDE INSIGHT

Cephalometric (Scan type)

PaX-i3D provides optimal images with an exclusively designed sensor for cephalometric diagnosis. As it offers two image sizes, LAT and Full LAT, you can choose one of them based on your diagnostic needs.

Built-in Sensor System

It enables you to acquire high quality images in a safe and comfortable environment. You don't need to spend time to change the sensor.

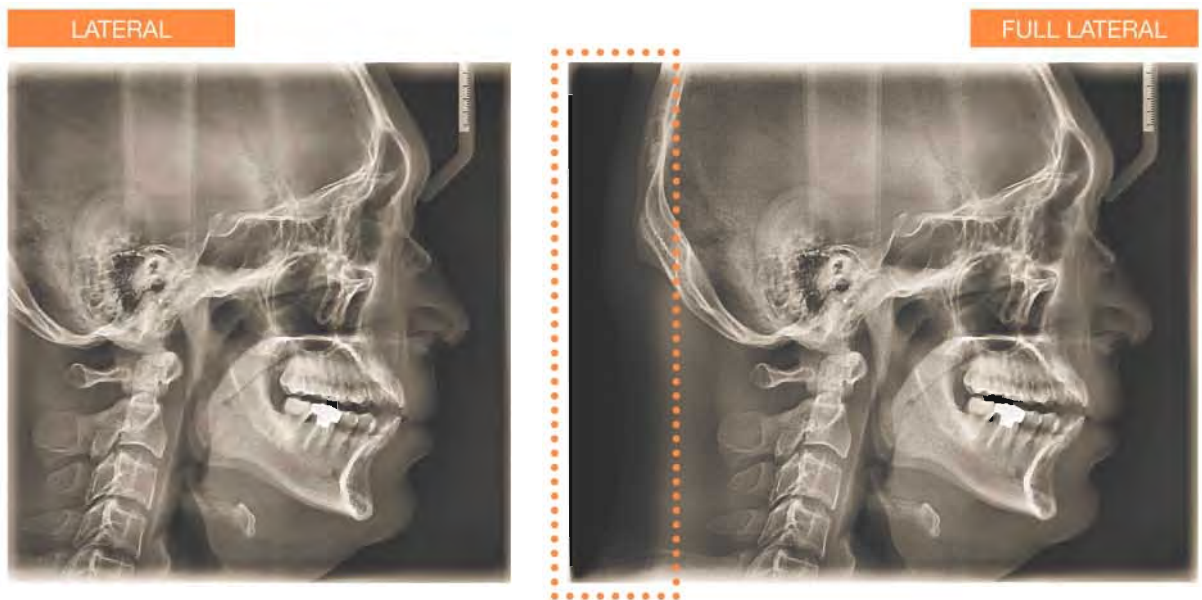

LATERAL

Provide specialized high quality images to suit orthodontics and maxillofacial surgeries.

FULL LATERAL

Full lateral image size is 30% wider and shows the occipital area of the patient, which enables comprehensive diagnosis.

Examination Program	Scan Time (sec.)	Scan Size (cm)
LATERAL	12.9	21 X 23
FULL LATERAL	16.9	25 X 23



ONE SHOT CEPH

With One Shot Ceph, you can acquire high quality images with low X-ray dosage. Plus, short scan time reduces distortion caused by patient movement.

Cephalometric (One Shot Type)

Superior image quality will be delivered using SI-TFT sensors. It provides up to three different image sizes in LAT and PA modes reducing unnecessary X-ray dose for patients. It makes your diagnosis more professional.

LATERAL (Inch)

SMALL (20X20)



MEDIUM (23X25)



LARGE (30X25)



OS (One Shot Standard) →

OP (One Shot Premium) →

PA



Carpus



SMV (Submentovertex)

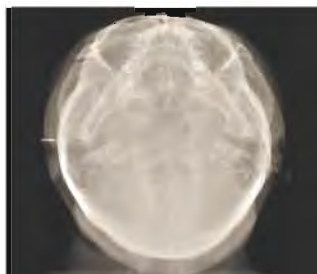

POWERFUL DIAGNOSTIC VALUE WITH PANORAMIC IMAGES



MAGIC PAN

MAGIC PAN creates a more superb panorama image. It is acquired thru the elimination of distorted and blurred images caused by improper patient positioning (Optional).

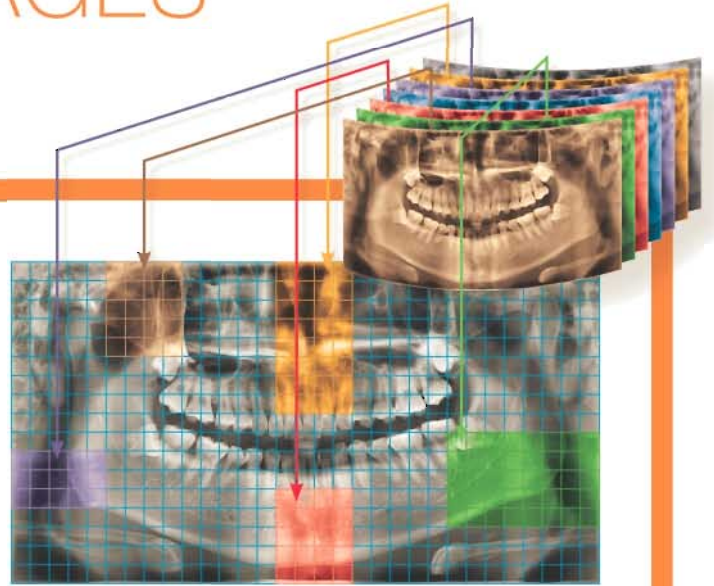

NORMAL



MAGIC PAN



Focused image is reorganized throughout the whole dental arch and the image quality can be increased. The image becomes clearer especially in the Incisor and canine region, TMJ areas and root canal.

Intuitive User Interface & Various Capture Modes

Mode	Detail Description
Standard	Standard, Right, Left, Front
Bitewing	
Orthogonal	
TMJ	PA / Lateral
Sinus	



PRODUCT CONFIGURATION

	CBCT	PANO	CEPH	
			SCAN	ONE SHOT
PaX-i3D	•	•	–	–
PaX-i3D SC	•	•	•	–
PaX-i3D OS	•	•	–	•
PaX-i3D OP	•	•	–	•

SPECIFICATION (PaX-i3D : PHT-6500)

Function	Pano + CBCT + Ceph	SC	21X23 [LAT, PA, SMV, Waters View, Carpus] 25X23 [Full LAT]
CBCT - FOV Size(cm)	8X8 : Multi [5X5 / 8X5 / 8X8] 12X9 : Multi [5X5 / 8X5 / 8X8 / 12X9]	OS	20X20 [LAT, PA] 23X25 [LAT, PA, SMV, Waters View, Carpus]
Voxel Size	0.12 mm / 0.2 mm / 0.3 mm	OP	20X20 [LAT, PA] 23X25 [LAT, PA] 30X25 [LAT, PA, SMV, Waters View, Carpus]
Scan Time	Pano : 10.1 sec (Normal) Scan Ceph : 12.9 sec (Full LAT -16.9 sec) One Shot Ceph : 0.9-1.2 sec CBCT : Standard_15 sec / High_24 sec	Gray Scale	14 bit
		Patient Position	Standing / Wheel-Chair Accessible
		Tube Voltage/Current	50-90 kVp / 4-10 mA

DIMENSION (Inch)

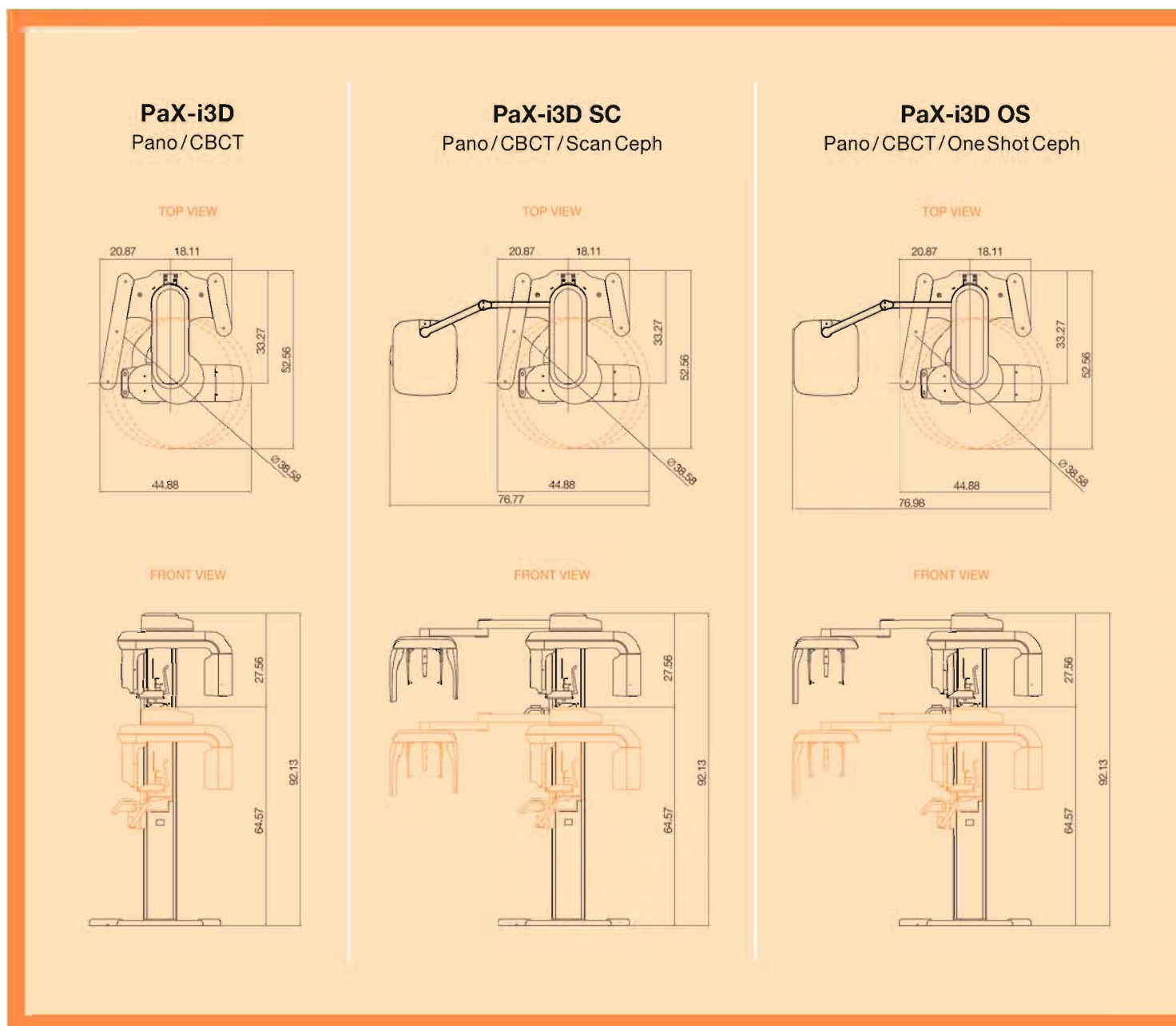

WORLDWIDE NETWORK

12 Overseas Subsidiaries and Business partners in over 80 countries.

EUROPE Belgium, Bulgaria, Czech, Croatia, Cyprus, France, Germany, Greece, Hungary, Lithuania, Moldova, Austria, Netherlands, Poland, Portugal, Romania, Russia, Slovenia, Slovakia, Spain, Switzerland, Sweden, Turkey, Ukraine, UK

ASIA Bangladesh, Brunei, China, Hong Kong, India, Indonesia, Japan, Malaysia, Pakistan, Philippines, Singapore, Sri Lanka, Taiwan, Thailand, Vietnam

SOUTH AMERICA Argentina, Bolivia, Brazil, Chile, Colombia, Nicaragua, Paraguay, Peru, Venezuela, Dominican Republic, Ecuador

NORTH AMERICA Canada, Mexico, U.S.A.

OCEANIA Australia

MIDDLE EAST, AFRICA Iran, Iraq, Israel, Jordan, Kuwait, Lebanon, Syria, Saudi Arabia, Qatar, U.A.E, Yemen, Egypt, Morocco, Libya, Palestine, Sudan, Algeria, Tunisia, Kenya, Nigeria, Zambia, Tanzania, Uganda, South Africa



Head Office Subsidiary Office

